

Direct Sampling SDR transceiver

MB1

HF/50 MHz/VHF TRANSCEIVER

USER MANUAL

1. READ IT FIRST	8
1.1 Congratulations	8
1.2 Features	8
1.3 Supplied accessories	10
1.4 Precautions	11
1.5 Software license agreement	13
1.5.1 ExpertSDR2 Software License Agreement	13
1.5.2 Windows 10 Software License Agreement	13
1.5.3 Other Software License Agreement	14
1.6 Copyrights	15
1.7 Contacts	15
2. CONNECTIONS	16
2.1 Antenna	16
2.2 Grounding	16
2.3 AC power	16
2.4 Front Panel accessories	17
2.4.1 Microphone(Dynamic/Electret)	17
2.4.2 Headphones	18
2.4.3 USB Devices	18
2.5 Rear Panel	19
2.5.1 Accessories	19
2.5.2 External PC	20
2.5.3 External Linear Amplifier	21
2.5.4 External Control devices	23
2.5.5 Reference input	24
2.5.6 XVTR	25
2.5.7 DAC OUT low power output	25
2.5.8 RX IN and RX OUT	26
2.6 Connectors pin-out	27
2.6.1 MIC1	27
2.6.2 MIC2	27
2.6.3 COM	28
2.6.4 EXT CTRL	29
2.6.5 PA PTT Outputs	30
3. FRONT PANEL DESCRIPTION	31
4. REAR PANEL DESCRIPTION	44
5. MAIN SCREEN DESCRIPTION	49
5.1 Main Window	49
5.1.1 Section 1	49
5.1.2 Section 2	50

5.1.3	Section 3	51
5.1.4	Section 4	53
5.1.5	Section 5	54
5.1.6	Section 6	55
5.1.7	Section 7	55
5.1.8	Section 8	55
5.1.9	Section 9	55
5.2	Local panels	56
5.2.1	ATU	56
5.2.2	MIXER	57
5.2.3	FRONT END SETTINGS	58
5.2.4	NFM-SETTINGS	59
5.2.5	DSP SETTINGS	60
5.2.6	PA SETTINGS	61
5.2.7	MIC/CW SETTINGS	62
5.2.8	VOX/COMPRESSOR SETTINGS	63
5.2.9	RX EQUALIZER	64
5.2.10	TX EQUALIZER	64
5.3	Options	65
5.3.1	Device menu	66
5.3.1.1	Device settings	66
5.3.1.2	Mic	67
5.3.1.3	VAC	68
5.3.1.4	VOX	69
5.3.1.5	DSP	69
5.3.1.6	TX	72
5.3.1.7	CW	74
5.3.1.8	Ext Ctrl	75
5.3.1.9	PA	76
5.3.1.10	Expert	77
5.3.2	Sound card menu	79
5.3.2.1	Sound card	80
5.3.2.2	Line output	82
5.3.3	Display menu	83
5.3.3.1	Main window	84
5.3.3.2	Spectrum	85
5.3.3.3	Waterfall	87
5.3.3.4	Grid	88
5.3.3.5	Filter	89
5.3.3.6	Background	90
5.3.4	CAT menu	91
5.3.4.1	RX1 receiver	92
5.3.4.2	RX2 receiver	94
5.3.4.3	OmniRig	96
5.4	Panel menu	97
5.5	Features menu	101
5.6	Manager menu	102
5.7	CW Skimmer menu	103

5.8	Shortcuts menu	105
5.9	MB1 Utility	106
5.9.1	Main	106
5.9.2	Sensors	108
5.9.3	Temperature	108
5.9.4	Fan Speed	109
5.9.5	About	110
5.10	Windows settings	111
5.10.1	Date and time settings	111
5.10.2	Switch off screen saver	113
5.10.3	Switch off sleep mode	116
5.10.4	Network adapter settings	119
5.10.5	System recovery	123
5.10.5.1	Create restore point	123
5.10.5.2	Use restore point	130
5.10.6	Windows password	138
5.10.6.1	Enable Windows password	138
5.10.6.2	Disable Windows password	140
6.	TECHNICAL CHARACTERISTICS	144
6.1	Receiver	144
6.2	Transmitter	144
6.3	Internal PC	145
6.4	Other	145
7.	TRANSCEIVER OPERATIONS	146
7.1	Turning ON/OFF the transceiver	146
7.2	Frequency Tuning	147
7.3	Adjusting the AF gain	149
7.4	Adjusting the RF gain	150
7.5	Muting the received audio	150
7.6	Internal speaker On/Off	151
7.7	Audio signals routing	151
7.8	Selecting the Operating Band	152
7.9	Using the Band Memory	153
7.10	Selecting the Operating Modes	154
7.11	ATT/PREAMP control	156
7.12	Selecting AGC presets	157
7.13	Frequency Tuning Lock	159
7.14	VFOA and VFOB control	159
7.15	Changing RX Filter width by knob	161
7.16	RX Filter Shifting	161
7.17	Select RX Filter presets	161

7.18	ZOOM-In ZOOM-Out the graphics	162
7.19	Squelch level adjusting	163
7.20	Adjusting RX Equalizer	163
7.21	DSP Functions	164
7.22	Meter	165
7.23	IQ files recording	166
7.24	Frequency Tuning STEP Changing	166
7.25	Front End filters switching	167
7.26	Antenna switching	167
7.27	Using RX IN input	169
7.28	Using RX OUT output	169
7.29	Functional buttons using	170
7.30	DRIVE level adjusting	171
7.31	Microphone gain control	172
7.32	Selecting the microphone's input	172
7.33	Compression level adjusting	174
7.34	VOX Operation	175
7.35	TX Monitoring Gain	175
7.36	Adjusting TX Equalizer	176
7.37	Voice Recorder Operation	176
7.38	Transverter mode operation	178
7.39	External PA control	178
7.40	Transmitting in Voice mode	180
7.41	Transmitting in CW mode	180
7.42	DAC OUT operation	180
7.43	CTCSS Tones using	181
7.44	Burst Tone using	182
7.45	EXT CTRL Configuration	183
8.	ATU OPERATION	184
9.	SPLIT OPERATION	186
9.1	SPLIT + Sub RX Operation	186
10.	SUB RECEIVER USING	188
11.	RIT/XIT OPERATIONS	189
11.1	RIT	189
11.2	XIT	190
12.	SHIFT BUTTONS OPERATION	191

13. DIGITAL MODES OPERATION	191
14. RX2 OPERATION	192

1 READ IT FIRST

1.1 Congratulations

Congratulations on your purchase of one of the best new generation SDR transceivers with Direct Digital Conversion and Digital Up Conversion!

The MB1 transceiver consists of an SDR transceiver and a fully functional personal computer in a single package, thus providing tremendous opportunities and flexibility for numerous applications!

1.2 Features

Check out this section before you start to operate on the air.

In this section you will learn about the transceiver's features, the supplied accessories, precautions and the license agreement.

The MB1 transceiver - is a new trend in amateur radio, a transceiver and a computer in a single package. It combines a classic design, developed over several decades, with the most advanced DUC/DDC SDR-technologies - Direct Digital Conversion (DDC) and Digital Up Conversion (DUC), plus a fully-featured high-end personal computer with an Intel Core i5 processor on board.

- Two independent receive channels with a bandwidth of 312 kHz
- Broadband overview of up to 80 MHz
- High quality IPS 7" touch screen display with a resolution of 1280x800 pixels
- ExpertSDR2 software in two versions: for Desktop and for integrated GUI display
- Opportunity to install any other software (applicable for Windows 10 OS) by the User
- Record and play on air fragments (IQ files) with a bandwidth of up to 312 kHz

Features of the transceiver

- An independent receive path with Digital Direct Conversion (DDC)
- A separate independent transmission path, constructed on the basis of Digital Up Conversion (DUC)
- Full duplex or half duplex modes*
- Two independent receivers with panorama's bandwidth up to 312 kHz and two sub-receivers in each of them
- 4 HF antenna connectors and 2 VHF
- Four separate programmable PTT output for external power amplifiers

- The ability to connect to VHF transverters
- The ability to use the transceiver as a measuring receiver
- The ability to use the transceiver as a signal generator (DAC OUT)
- Very minor delay in CW mode (about 10 ms)
- Ability to use the transceiver in SO2R mode
- Remote control operation
- Embedded power supply unit

** Full-duplex mode is supported by the transceiver's hardware, but is not implemented in the firmware and software yet. This mode will be implemented in future versions of ExpertSDR2 software*

PC capabilities of your transceiver

- Installation of digital modes software
- Installation HAM and Contest logs
- Two CW Skimmers may be used on different bands
- The transceiver can connect to the LAN and the Internet
- Use of Internet applications (e.g. e-mail, Skype, ICQ, TV, etc.)
- Play video and audio files
- Watch TV via USB-receivers
- Ability to connect two external displays, keyboard, mouse

1.3 Supplied accessories

The transceiver may be supplied with the additional option of an Automatic Tuner Unit (ATU) for impedance matching antennas with the 50 ohm output path of the transceiver.

Basic configuration:

- MB1 transceiver
-

Note:

 *ATU is **not** installed in the transceiver in the Basic configuration*

- PTT-microphone MD15
- Power Supply Cable to connect the transceiver to an AC mains network
- Backup fuse 5A

Standard configuration:

- MB1 transceiver + ATU
-

Note:

 *ATU is installed in the transceiver in the Standard configuration*

- PTT-microphone MD15
- Power Supply Cable to connect the transceiver to an AC mains network
- Backup fuse 5A

Additional equipment:

Additionally you can purchase the following devices:

- [Computer Headset with electret microphone](#)
- [PTT footswitch](#)
- [E-Coder panel](#) or [E-Coder mini kit](#) for convenient remote operation

1.4 Precautions

To prevent damage to the transceiver, please read these operating rules carefully before attempting to operate the transceiver.

- Carefully read this manual first, otherwise connecting and operating the MB1 could lead to the fatal errors
- Before connecting the device to the AC network 110-220 V 50-60 Hz, visually inspect the MB1 for the absence of mechanic damage
- **DO NOT** use the MB1 in temperatures lower than 0°C (32°F) and higher than +60°C (140°F)
- If the MB1 was stored in abnormal climatic conditions, it is recommended to keep it in normal operating temperatures for at least 2 hours before switching on
- Before connecting the MB1 to the AC power line, ensure it is grounded. **Never** use the MB1 transceiver without grounding!
- Before connecting external devices read the Connections Section
Note, the MB1 output switches are limited to the values of the supply voltage and the current passing through them, **do not** allow polarity reversal
- Only connect external devices to the MB1 in accordance with the wiring diagrams shown in this manual
- **Never** connect external devices to the MB1 transceiver which are live or in a switched-on condition
- Use **only** AC networks in the range of 110-220V. Remember - the device supplied with AC voltage with a frequency of 50-60 Hz
- **Never** use or store the MB1 in dusty rooms, nor allow prolonged exposure to direct sunlight
- Avoid the exposure of the atmospheric downfalls on the MB1 and never spill any liquids (especially aggressive) on it
- **Do not** emit HF/VHF signal with power more than 1W in the same room or near the MB1 transceiver
- **Do not** open the MB1. It contains radio components, which are highly sensitive to static electricity. For any repairs to the product please contact the manufacturer
- **Do not** transmit without a load (dummy load/matched antenna) - this will lead to overheating of the active output devices, and possibly cause their thermal breakdown. The same applies to an unmatched load
- If the transceiver emits an abnormal odor, or smoke, **immediately** turn it's power OFF and remove the power cable. Contact the nearest Expert Electronics dealer for advice
- **Never** stand the transceiver on the front or rear panel - this may lead to damage of the controls and/or the display

- **Always** take great care when moving or transporting the transceiver
- Maintain a minimum distance of 10cm between the cooling vents of the transceiver and another object
Never cover the cooling vents which must always be open to allow sufficient ventilation. Failure to do so may cause malfunctions
- Be careful to avoid dropping metal objects (screws, clips, metal filings, etc.) through the vents, which may cause damage to the transceiver
- **Always** disconnect the antenna from the MB1 when not in use, or if there is a danger of atmospheric electricity
- Ground the antenna-mast and antenna-feeders to avoid accumulation of atmospheric static electricity on them
- **Always** use ferrite beads on antenna and other cables, connected to the transceiver
- Ensure the MB1 and any connecting cables are free from the effects of electromagnetic interference and uncontrolled currents and voltages
- To avoid damage to the MB1 or causing harmful interference on air, it should **only** ever be operated by competent persons
- Keep the MB1 out of the reach of children

1.5 Software license agreement

1.5.1 ExpertSDR2 Software License Agreement

The MB1 transceiver runs under ExpertSDR2 software (MB1 version).

ExpertSDR2 software (MB1 version) is the proprietary product and intellectual property of Expert Electronics. It is forbidden to modify, copy or disclose to third parties ExpertSDR2 (MB1 version) software distribution.

When shipped the MB1 transceiver supplied with the latest official ExpertSDR2 software (MB1 version). Official versions of the software are published on the manufacturers website in section "MB1 Transceiver/Downloads".

New versions of the MB1 transceiver software may have different titles from time to time. This license agreement applies to all new versions of the software and may be supplemented and / or amended unilaterally by Expert Electronics.

The manufacturer reserves the right to alter and / or improve the MB1 transceiver software, adding new features and bug fixes. In this regard, the software may be different from the description herein. Ask your closest dealer on the availability of new, more complete version of the User Manual, or look for them on the official website of the manufacturer in the section "MB1 Transceiver / Documentation".

Users of the MB1 transceiver can update the MB1 software themselves by downloading from the official website of the Expert Electronics company.

The manufacturer is not responsible for the consequences of the user utilizing an unofficial or modified version of ExpertSDR2 software (version MB1) on the MB1 transceiver and/or changes the settings or other files which are related to the ExpertSDR2 (version MB1) functionality.

1.5.2 Windows 10 Software License Agreement

The built-in PC of the MB1 transceiver, runs under licensed Microsoft's Windows 10 OS.

Use of the Windows 10 OS must be carried out according to Microsoft license agreement.

You can read the Microsoft License Agreement in Windows settings: START--SETTINGS--System--About--Read the Microsoft Software License Terms.

MB1 User is responsible for compliance with the Microsoft License Agreement. The manufacturer assumes no responsibility for compliance with the Microsoft License Agreement.

1.5.3 Other Software License Agreement

The user can install in the MB1 transceiver any third-party software, supported by Windows 10 Home OS, 64 bit.

If you install third-party software you must follow:

- The license agreement for the ExpertSDR2 software (MB1 version)
- The Microsoft Windows 10 license agreement
- The third party software license agreement, which you are going to install or is already installed

The manufacturer assumes no responsibility for material, moral or any other kind of damage, whether expressed or implied, by the use of third-party software.

The manufacturer assumes no responsibility for material, moral or any other kind of damage, whether expressed or implied, by the virus-software, which may appear while using the MB1 transceiver.

The manufacturer assumes no responsibility for material, moral or any other kind of damage, whether expressed or implied, by the external devices used along with the MB1 transceiver.

1.6 Copyrights

Expert Electronics company holds copyrights for the MB1 transceiver, intellectual property: ExpertSDR2 software, MB1 Utility and all User Manuals and Instructions for the device and software.

Before you are going to share this document in the Internet or via email, get written (or via email) permission to do that.

It is forbidden to present this document as your own, sell it or use it in any other commercial activity.

Expert Electronics company does not guarantee, that the functions and their qualities described in this manual, and also combinations which were not described in the manual, comply with the User purposes, if it is not mentioned in the Manual. Expert Electronics company does bear any responsibility for material, moral and other kinds of damage to the expressed or implied for such actions.

1.7 Contacts

MANUFACTURER

Expert Electronics LLC

Web-site: www.eesdr.com

E-mail: info@sunsdr.com

You can contact us via mentioned above phone numbers about: your orders, technical support (questions about design and operating of SDR-devices), software support.

2 CONNECTIONS

2.1 Antenna

Before connecting the antenna, check the integrity of the antenna-feeder path.

For best results, the antenna should have an impedance of 50 Ohm to match the 50 Ohm impedance of the HF nodes of the transceiver.

The antenna should have SWR level not worse than 1.5:1. If the SWR is worse than 1.5:1, match the cable and the antenna to the desired level and/or use an ATU.

Note:

 Using a mismatched antenna-feeder path might cause non-linear distortion of the transmitted signal, HF interference on the transceiver's cables and/or interference of TV's or other devices.

 Transmitting using a receiving antenna may damage it.

Warning!

① **Always use E-type ferrite beads on antenna and other cables, connected to the transceiver!**

2.2 Grounding

To eliminate the risk of electric shock it is essential to use a reliable grounding connection for the transceiver.

Warning!

① **Never use water or gas pipes for grounding!**

① **Never use the MB1 transceiver without reliable grounding!**

2.3 AC power

Connect the transceiver to the AC mains network with the power cable supplied with the transceiver. Make sure, that the power outlet has the grounding/earth terminal and that it matches the type of the power cable in use.

Warning!

① It is recommended to set the E-type Line Filter on the Power Supply cable near the rear panel of the transceiver.

2.4 Front Panel accessories

You can connect different accessories to the front panel of the MB1.

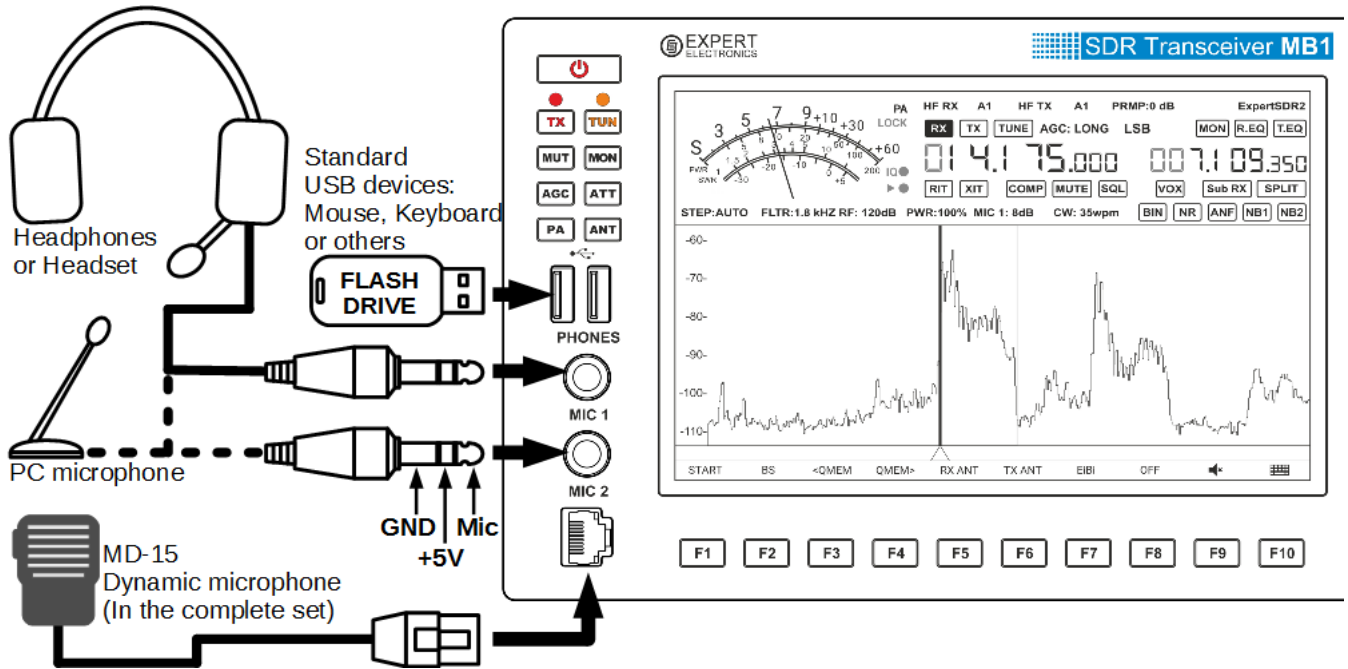

2.4.1 Microphone(Dynamic/Electret)

Dynamic microphone. The transceiver's kit includes a standard dynamic MD-15 microphone with PTT button - to activate transmission.

MD-15 microphone connects to the **MIC2** connector on the front panel of the transceiver.

MIC 2 microphone input is designed to connect dynamic microphones with an output impedance of 500-600 Ohm. **MIC 2** connector pinout is shown in section [MIC 2](#)²⁷.

Note:

☎ By repeated short presses of MIC button, you can select the **MIC 2** input in the software, to work with a dynamic microphone.

Electret microphone. Not supplied with the transceiver.

MIC 1 microphone input on the front panel of the transceiver is designed to connect electret microphones.

You can connect any computer or other electret microphones via the Adapter Jack 6.3mm - 3.5mm.

Note:

☎ By repeated short presses of MIC button, you can select the **MIC 1** input in the software, to work with an electret microphone.

Line-In input.

MIC 1 input on the front panel of the transceiver can be used as a line-in input.

To connect line-in only use a **monophonic** 6.3 mm Jack Plug.

2.4.2 Headphones

Connect headphones to the **PHONES** jack. You can use headphones with an impedance from 8 to 64 Ohm or active speakers.

To connect headphones use **stereo** 6.3 mm Jack Plug.

Warning!

① **Never use headphones with a mono connector! If you have monophonic headphones, use stereo 6.3 mm Jack and connect them to one of the channels.**

① **Never connect two stereo channels to each other!**

Note:

📞 *When you connect headphones to the transceiver, the internal speaker will continue to operate. To disable it, go to a sound's local panel and turn off the speaker with **SPEAKER** button (more details in [Local panels](#) ⁵⁶).*

📞 *Headphones with high impedance may sound quieter.*

2.4.3 USB Devices

You can connect any standard USB device with current consumption of up to 500 mA to the **USB** connectors.

e.g.: flashcards, mouse and keyboard, wireless mouse and / or keyboard, WLAN adapters etc.

Note:

📞 *After connection of the USB device, it may take some time to search and automatically install the drivers for the new device. After installation, the OS will begin to work with the USB device in regular mode.*

📞 *In some cases, it may be required, to search for drivers over the Internet and / or use manual installation.*

📞 *Older USB devices may not be supported by the Windows 10 Home x64. Read the Instructions for your USD device to make sure that it is supported by the Windows 10 Home x64 OS.*

2.5 Rear Panel

2.5.1 Accessories

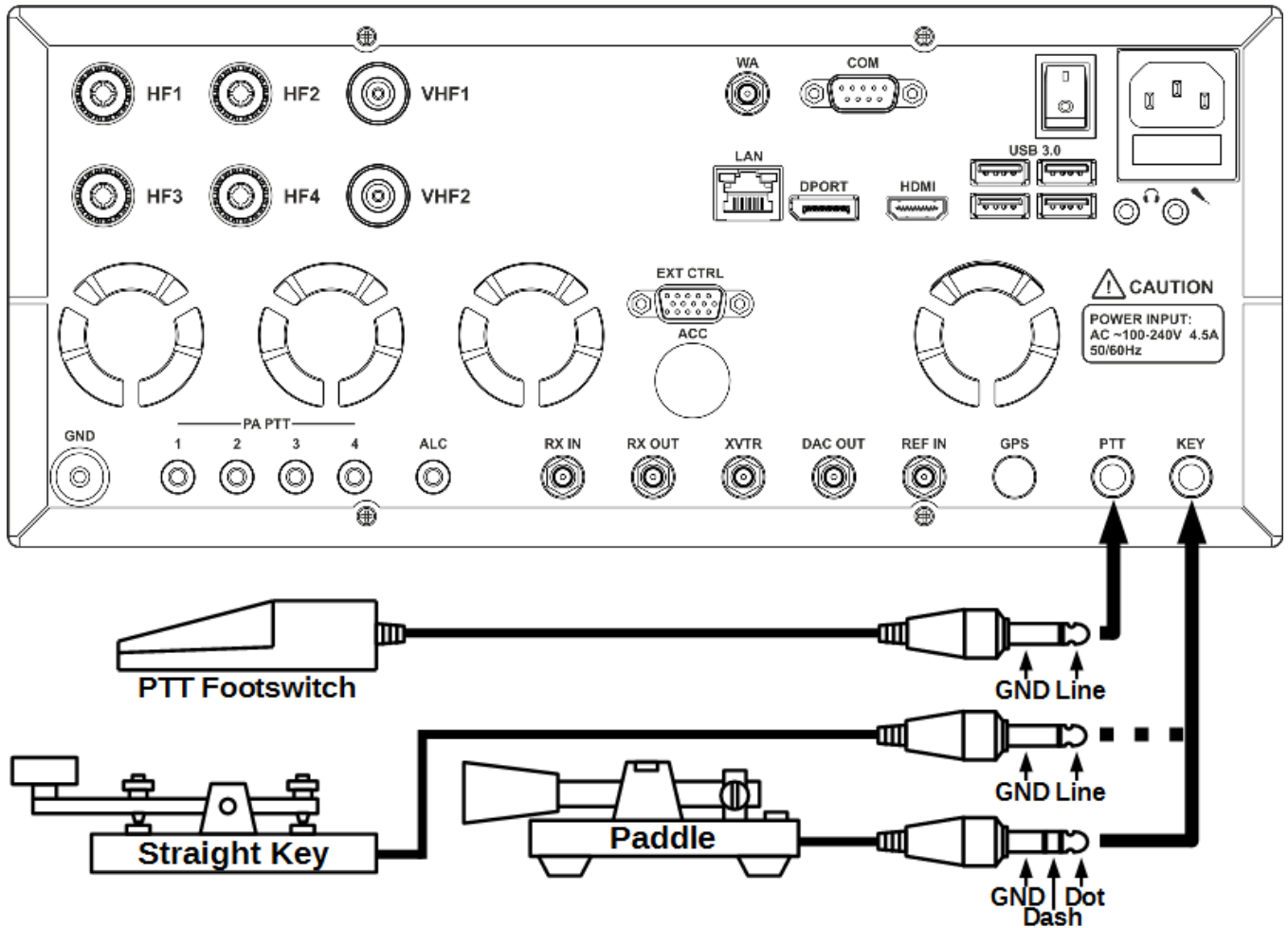

You can connect several accessories to the transceiver's rear panel, as shown on the picture above.

PTT Footswitch. Connects to the **PTT** socket and controls transceiver's TX mode. Connector type - 6.3 mm Jack.

When you press the footswitch, **PTT** Line connects to the Ground (Case), it causes the transceiver to switch into the TX mode. A red LED TX indicator on the front panel and in the software window, indicates that the TX mode is on.

Releasing the footswitch returns the transceiver to the RX mode.

Straight Key. Connects to the **KEY** socket using the mono 6.3 mm Jack. Pressing the key switches the transceiver to the TX mode and when closed generates a continuous CW signal (manual mode). The key is manipulated according to the message required.

Releasing the straight key returns the transceiver to the RX mode.

Twin-paddle key (single-paddle). Connects to the **KEY** socket using the stereo 6.3 mm Jack. Pressing one of the key's paddles (or one side - for single-paddle) will switch the transceiver to the TX mode and begin automatic generation of dots and dashes. Releasing the paddle returns the transceiver to the RX mode.

Note:

 *Tuning and switching of manipulation modes, speed and other parameters of the CW signal, can be done in the local panel on the transceivers display (more details in [Transmitting in CW mode](#)^{D180}).*

COM-port for connection of the CW key.

CW paddle can also be connected to the **COM**-port as per the picture below.

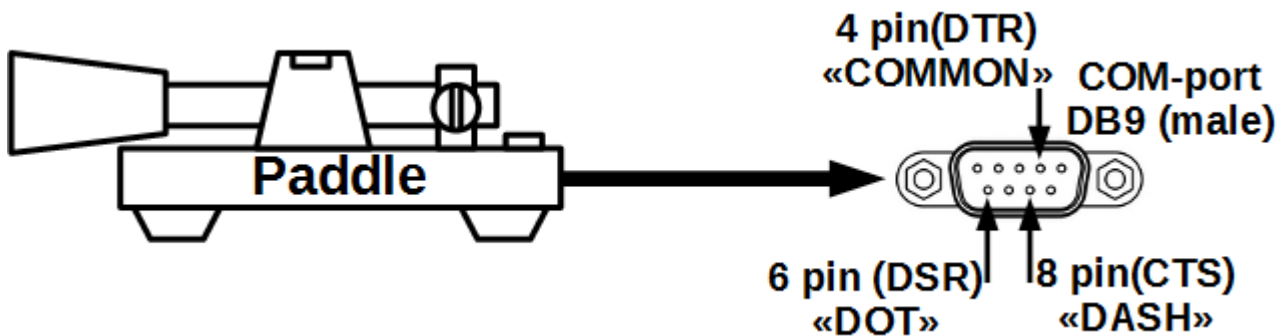

Warning!

ⓘ While connecting a CW key to the COM-port, avoid any contact of the key with the transceivers's case, other devices' chassis and/or any other earth point!

2.5.2 External PC

The transceiver can be connected to another PC with a **COM**-port cable. Using the **COM**-port cable and the CAT-system, you can adjust the transceiver's frequency and it's other parameters.

Note:

 *The cable type should be Null modem / crossing.*

 *While connecting the cables, transceiver and PC should be switched off.*

Transceiver may be connected to the other PC via Ethernet cable. With that connection you create local network between PC and transceiver. There are may be more PCs if you connect them via commutator or router.

The transceiver may be connected to another PC via a WLAN connection. To do that, connect a WLAN adapter to a **USB**-port.

Also you may want to send audio signals to the transceiver and/or receive them from the transceiver.

To do that you may use MB1's audio cards (on the rear panel) or the audio cards of the other PC.

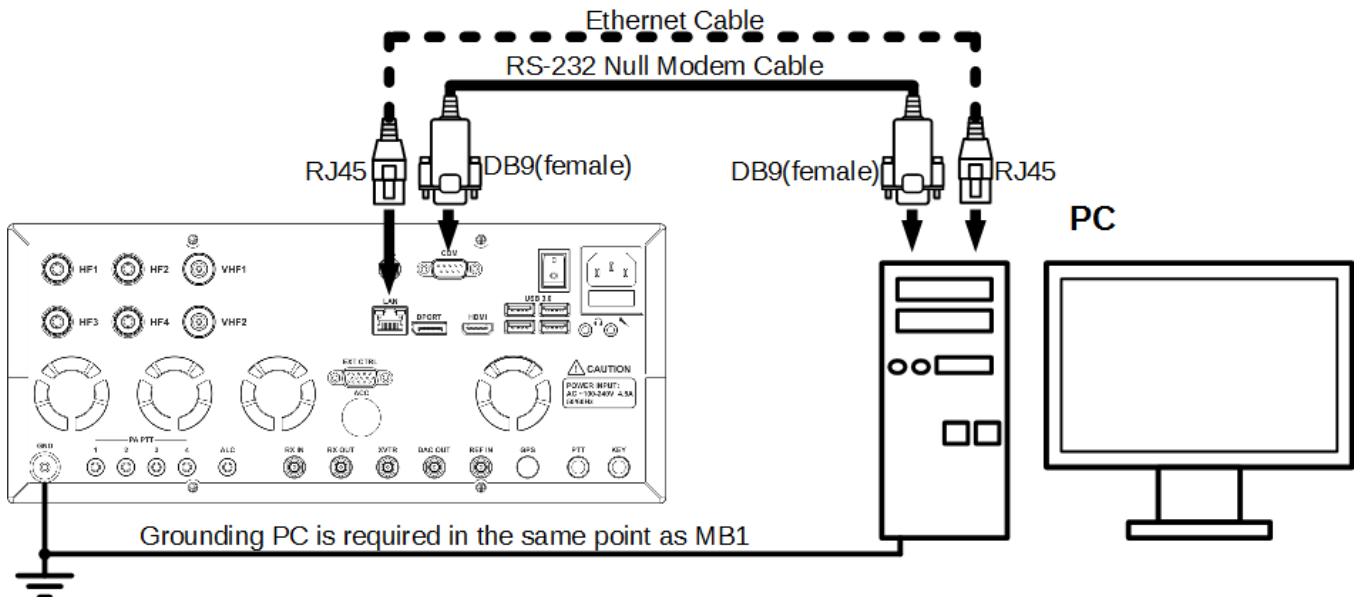

2.5.3 External Linear Amplifier

You can connect external Power Amplifiers (PA's) to the transceiver.

It may be required to connect more than one Amplifier depending on the type of the external PA wanted.

Connect a 50 Ohm HF cable to one of the transceiver's antenna connectors HF1 ... HF4 (SO 239) or VHF1 ... VHF2 (N-type), if it is VHF band PA. The other end of the cable connects to the input of the PA.

If the PA can be controlled via the CAT system, for switching bands and / or tuning of the HF circuits, you can use the "null modem" **COM**-port cable to control the amplifier.

To switch the PA to the transmission mode, normally you use a connection to the PA's control line and the PA's case. The MB1 transceiver provides four separate **PA PTT** sockets for connecting the control lines and the case, for four external PA's. Use one of the lines to control a PA's transmission mode with RCA-type phono plugs. You can set the switching delay of an external PA from RX to TX and back from TX to RX, in the transceiver's settings, if required (more details in [Local panels](#)⁵⁶).

If an external PA supports communication with the transceiver's **ALC** system, you can connect it via cable with RCA-type phono plugs. The voltage adjustment range for ALC -3...0 V (see warning below).

To control the external PA TX mode you can also use X8 pin terminal of the **EXT CTRL** connector (more details in [EXT CTRL devices](#)^{□23}).

Note:

☎ While connecting the cables, transceiver and PA should be switched off.

☎ If the **COM** -port of the transceiver is not available for some reason, then instead of the COM -port cable you could use the cable with an USB-COM adapter, to one of the transceiver's **USB** -ports. In this case, the virtual **COM** -port of the adapter should be set up in the MB1 OS.

Warning!

① There is a small natural delay in the ALC-system functionality, which may lead to short-term overload of the external PA. This phenomenon could cause off-frequency emissions or failure of your PA! The User of the MB1 transceiver should understand and accept the above, taking responsibility for the potential consequences of the use of the ALC-system. The manufacturer is not responsible for direct or indirect damages of any kind from using the ALC-system.

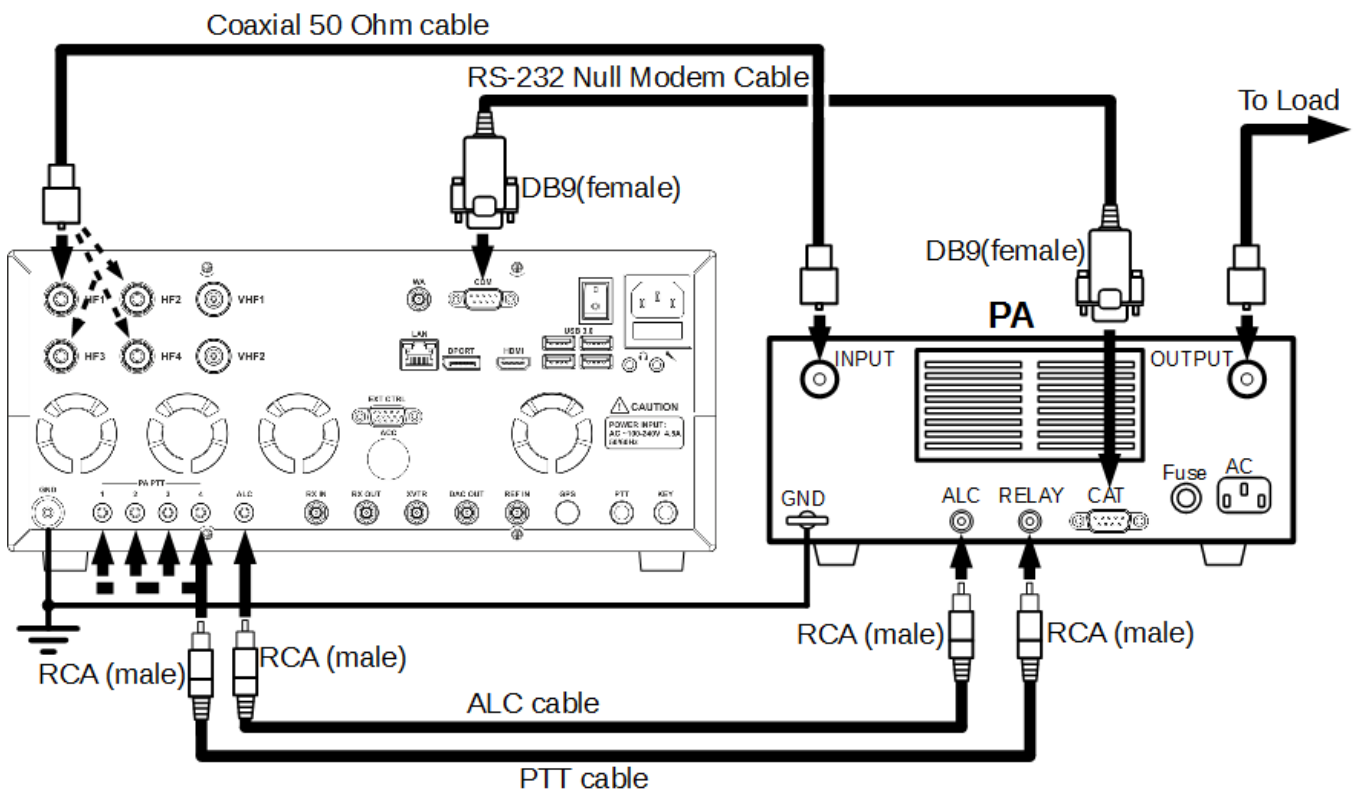

2.5.4 External Control devices

The MB1 transceiver allows you to control external devices via seven built-in electronic keys through the **EXT CTRL** connector.





The picture below shows the connection schematics between the relay and the pins of the **EXT CTRL** connector. With the help of the keys you can have direct control of antennas, external band filters, external PA's bands, HF preamplifiers, external transverter PTT etc.

Commutation is dependent on the band and RX/TX mode.

Adjusting of the keys' triggers can be made in the software Settings (more details in [EXT CTRL Configuration](#)¹⁸³).

The **X7** terminal can be configured as thermostat for enabling of the external fan. The transceiver measures the internal temperature and enables or disables external fan, depending on the settings (adjusted by the User). The Fan can be used for additional ventilation of the transceiver. You could also connect a relay to this terminal to control the room cooling system or other systems, dependent on the transceiver's temperature.

Note:

-  The Electronic keys have built-in protection diodes for inductive loads (relays, fans, solenoids, etc.) with a maximum reverse voltage of 75 V and current up to 200 mA (diodes 1N4148). If your inductive load gives a higher reverse current, it is necessary to use an external diode, which is situated parallel to the connected load. See diagram below.
 -  The **X8** terminal is designed for control of the external PA.
 -  The total load on the power output + 12V (Conn. 14) of the **EXT CTRL** connector must be less than 1 A.
 -  There is a protective fuse for current of 1 A installed on the SDR board, inside the transceiver.
 -  There is a diode connected in series with the power output + 12 V (Conn. 14) to avoid an outside voltage supply reaching inside the transceiver.
-

Warning!

- ❶ Incorrect connection of external devices and / or uncontrolled galvanic connections could lead to the malfunctions of the MB1 transceiver or its failure!

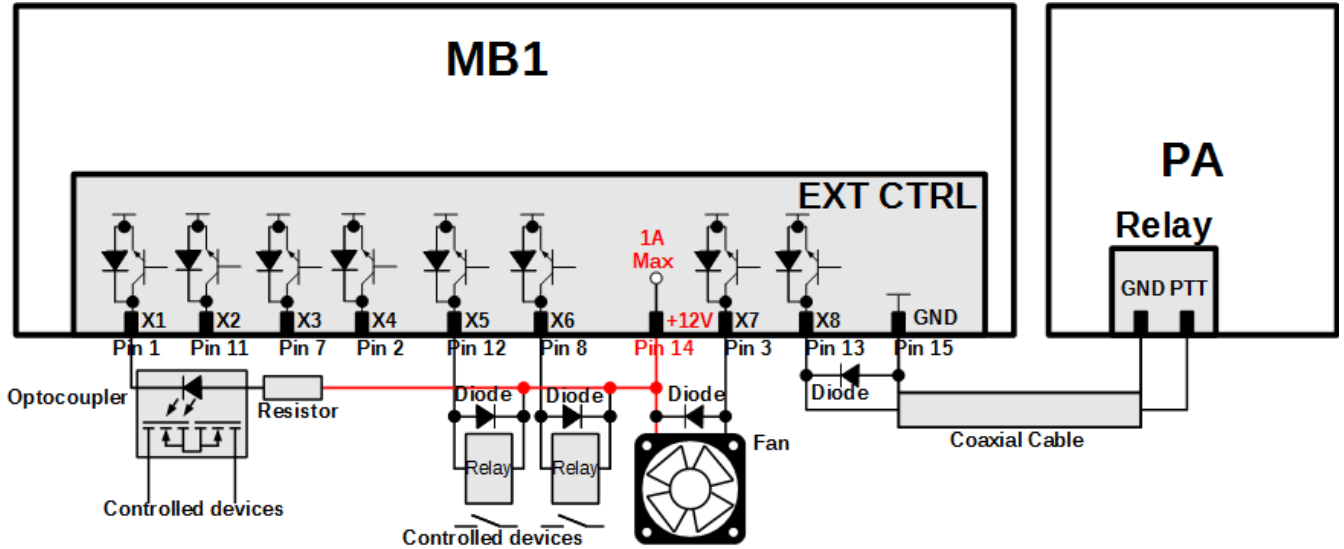

2.5.5 Reference input

A 10 MHz external reference oscillator can be connected to the REF IN connector with coaxial cable.

Enable the transceiver to use an external reference oscillator in the SDR software - checkbox **Use External Reference Input** (more details in [Options](#)⁶⁵).

Signal parameters of the Reference Frequency:

- Reference signal frequency of 10 MHz
- Reference signal voltage: min. 2.5 V (peak-to-peak) max. 3.3 V (peak-to-peak)
- Input impedance of 500 Ohm
- SMA type connector (female)

Note:

📞 **REF IN** is used to increase the stability of the transceiver's tuning frequency, if the built in stability +/- 0.5 ppm is not enough. It requires external reference oscillator with greater frequency stability. Also transceiver's frequency synchronization with an external reference oscillator is used when you want to synchronize several devices to each other, from one reference oscillator.

📞 The Phase frequency of the transmitted and received signals depends on the phase frequency of the external reference oscillator.

2.5.6 XVTR

Transverters for the VHF, SHF bands may be connected to the transceiver via the **XVTR** connector.

In RX mode, the XVTR functions as the input, in TX mode the XVTR functions as the output.

In TX mode, there is a constant +5V on the signal line with the HF signal. This constant voltage may be used for automatic control of the transverter in TX mode.

VHF, SHF band Transverters may also be connected to the transceiver via the **RX IN** and **DAC OUT** connectors.

RX IN used as the input in RX mode. **DAC OUT** is used as the output in the TX mode.

The **DAC OUT** connector does not have DC voltage for controlling TX mode, so it is necessary to use an additional TX mode controlling line, while you use it. You could use any **EXT CTRL** key connector or **PA PTT** line (more details in [EXT CTRL devices](#)^{□23}).

XVTR input/output parameters:

Intermediate Frequency: 1...70 MHz, 90...150 MHz

IF band: up to 80 MHz

Impedance: 50 Ohm

XVTR input sensitivity: -115 dBm

Signal level in TX mode: +10 dBm (max)

DC level: +5 V (in TX mode)

2.5.7 DAC OUT low power output

DAC OUT is the transceiver's low-power output, which functions in the wide frequency band.

It could be used for connection of external power amplifiers, transverters and as a source of a measuring signal.

To work with **DAC OUT** choose it in the antenna switch menu (more details in [Local panels](#)^{□56}).

DAC OUT output parameters:

Frequency band: 0.1...150 MHz

Transmitted signal band: 20 kHz

Impedance: 50 Ohm

Signal level: +10 dBm (max)

2.5.8 RX IN and RX OUT

RX IN connector is the direct input, bypassing Band Pass Filters (BPFs).

RX IN connector may be used for connection of the receiving antennas, transverters, additional BPFs, preamplifiers, attenuators etc.

Note:

 *The signal from **RX IN** connector goes to the ADC input and may be amplified by the preamplifier +10dB, if it will be chosen in the software.*

Warning!

① **Maximum allowed signal level on the RX IN connector is 0.3V of the active voltage (RMS). Do not exceed it, it may result in the transceivers overload and ADC fatal damage.**

RX OUT connector is the output of the transceivers receive path. The signal transferred to the transceivers HF path via active antenna input, goes to the RX OUT, when the RX IN is chosen.

Between **RX OUT** and **RX IN** connectors may be added additional filter or box of filters, preamplifier, attenuator, signal divider etc.

Note:

 *The signal passing through the transceivers HF path could be affected by the attenuator - 20dB, if it will be chosen in the software.*

2.6 Connectors pin-out

2.6.1 MIC1

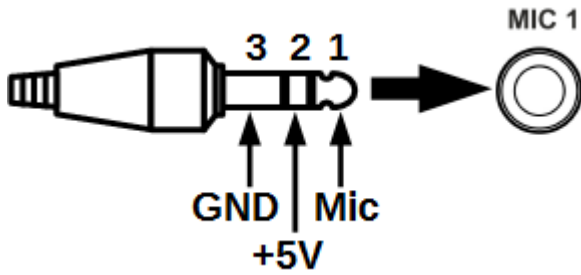

Out #	Output name	Description	Note
1	MIC	Mic signal input	Input
2	+5V	DC 5V supply into the MIC	Output
3	GND	Ground	--

2.6.2 MIC2

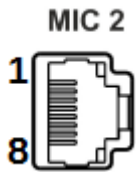

Out #	Output name	Description	Note
1	NC	Do not connect	--
2	GND	Ground	--
3	PTT	PTT signal input Connection of the PTT to the GND will turn the transceiver to the TX mode	Input
4	MIC	Mic signal input	Input
5	MIC_GND	MIC case	--
6	+5V	DC 5V output with maximum current up to 20 mA	Output
7	NC	Do not connect	--
8	NC	Do not connect	--

2.6.3 COM

COM (Male)

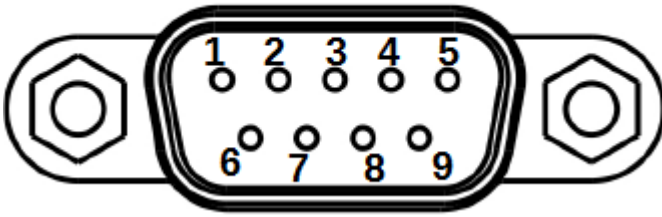

Out #	Output name	Description	Note
1	DCD	Data Carrier Detect - DCE is receiving a carrier from a remote DCE	Input
2	RxD	Received Data - Carries data from DCE to DTE	Input
3	TxD	Transmitted Data - Carries data from DTE to DCE	Output
4	DTR	Data Terminal Ready - DTE is ready to receive, initiate, or continue a call	Output
5	GND	Ground	--
6	DSR	Data Set Ready - DCE is ready to receive commands or data	Input
7	RTS	Request To Send - DTE requests the DCE prepare to transmit data	Output
8	CTS	Clear To Send - DCE is ready to accept data from the DTE	Input
9	RI	Ring Indicator - DCE has detected an incoming ring signal on the telephone line	Input

2.6.4 EXT CTRL

EXT CTRL

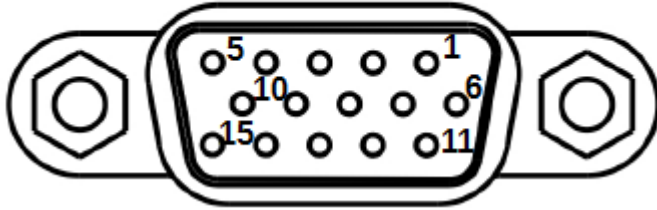

Out #	Output name	Description	Note
1	X1	Programmable key with open collector	Output
2	X4	Programmable key with open collector	Output
3	X7	Programmable key with open collector	Output
4	RB	RS-485 (-) Line	Input/ Output
5	I2	Connection of buttoned detector. Connect to ground. In reserve.	Input
6	CP	Contact of protected diode	--
7	X3	Programmable key with open collector	Output
8	X6	Programmable key with open collector	Output
9	RA	RS-485 (+) Line	Input/ Output
10	I1	Connection of buttoned detector. Connect to ground. In reserve.	Input
11	X2	Programmable key with open collector	Output
12	X5	Programmable key with open collector	Output
13	X8(PTT)	Programmable key with open collector for control of external PAs PTT	Output
14	+12V	DC 12V supply, current up to 500 mA There is a 1A fuse integrated in the line	Output
15	GND	Ground	--

Note:

☎ Trigger of the electronic key with open collector, leads to key's ground connection. Voltage drop equals 0.7V.

☎ RS-485 interface is reserved.

☎ Logic inputs of the buttoned detectors are reserved.

Warning!

- ① **Maximum current allowed via electronic keys is 450 mA!**
- ① **While connecting inductive load (relay, solenoids, fans etc.) to the X1-X8 keys, it's important to connect the protective diode in parallel to the load!**

2.6.5 PA PTT Outputs

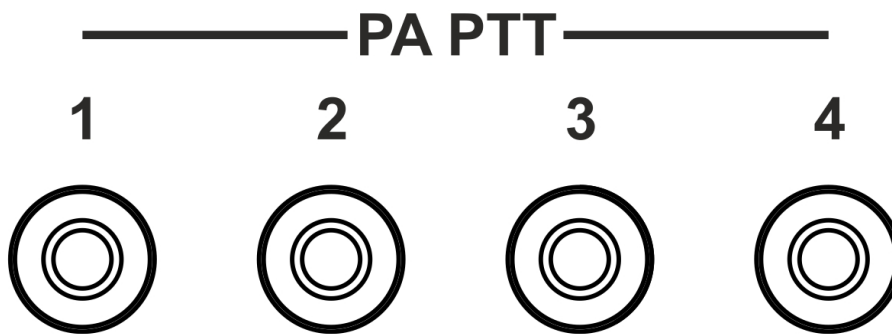

Central contacts of the RCA connectors connects to the electronic keys with open collector. Cases of the connectors are connected to the transceivers case.

Note:

☎ Trigger of the electronic key with open collector, leads to key's ground connection. Voltage drop equals 0.7V.

Warning!

- ① **Maximum current allowed via electronic keys is 150 mA!**
- ① **While connecting 1-4 inductive loads (relay, solenoids, fans etc.) to the electronic keys, it's important to connect the protective diode in parallel to the load!**
- ① **In MB1 transceivers released after 15.05.2016 used relays instead of electronic keys.**
Relays contacts are opened.
Maximum current allowed via relay 2A.

3 FRONT PANEL DESCRIPTION

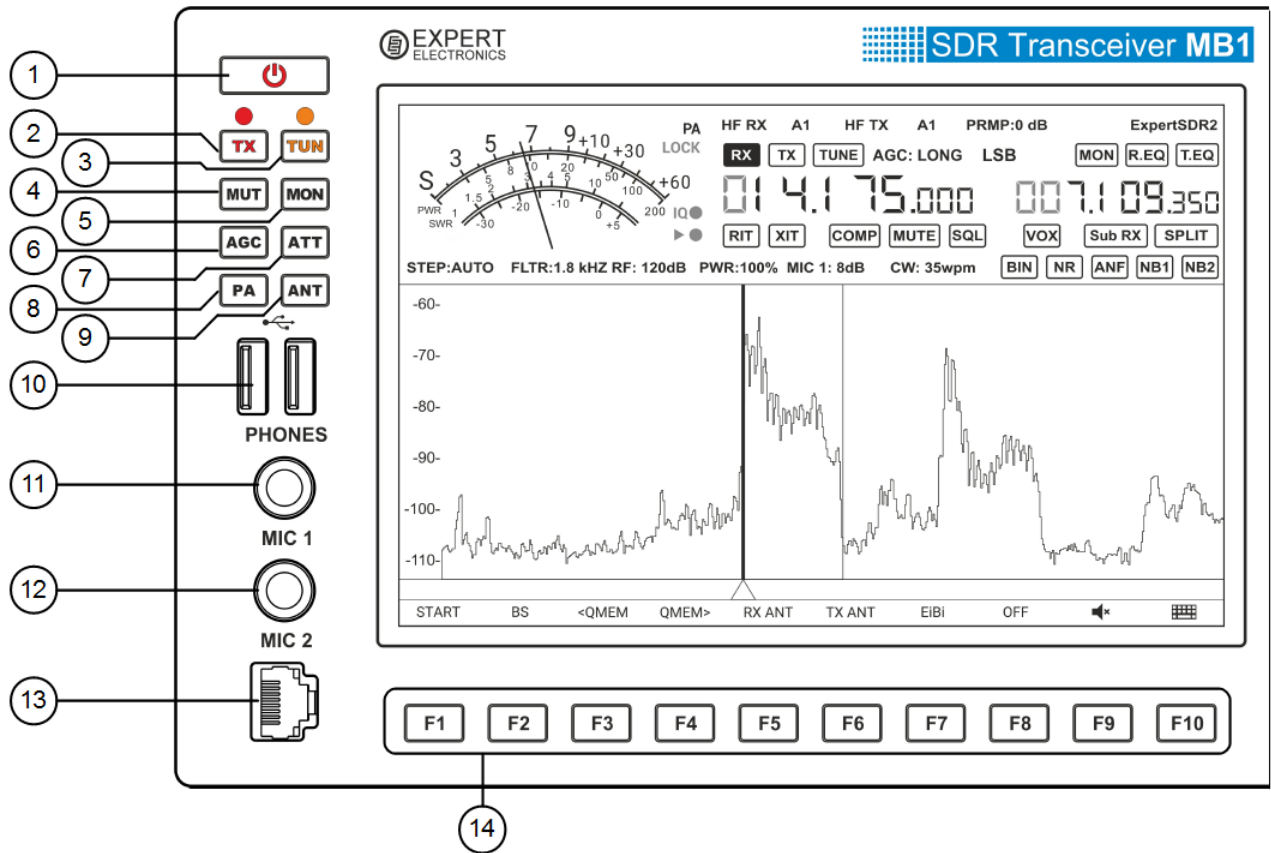

- 1)  - **Power button.**
Press the power button to turn the transceiver **on** and **off** (more details in [Turning ON/OFF the transceiver](#)¹⁴⁶).
- 2) **TX** - Button to turn on transmission mode.
Press to put the transceiver in transmission or receiving mode.
A red LED indicates that transmission mode is on. Press one more time to put the transceiver in receiving mode.
- 3) **TUN** - Automatic Tuner Unit on button.
Short press the TUN button to start the matching process (more details in [ATU operation](#)¹⁸⁴).
An orange LED indicates that the settings mode is switched on.
Press and hold TUN button to enter local ATU menu (more details in [ATU operation](#)¹⁸⁴).

Note:

 If the ATU option is not installed, when pressing the TUN button the transceiver will go to transmission mode and will transmit the center frequency.

- 4) **MUT** - Mute button.
Short press the MUT button to turn off the volume. Pressing again restores the volume.
Press and hold MUT button to enter the settings panel of the sound mixer (more details in [Audio signals routing](#)^{□151}).
- 5) **MON** - Button to enable monitoring your signal while transmitting.
Press the MON button to monitor the transmission. Pressing the button again turns off the monitor.
- 6) **AGC** - Switching AGC modes.
Press the AGC button to select the required AGC mode.
Successive presses cycles through the AGC modes. (more details in [AGC presets choosing](#)^{□157}).
- 7) **ATT** - Receiver's preamplifier control button.
Short press the ATT button to select the desired level of the receiver's preamplifier.
Successive presses cycle through the preamplifier levels.
Press and hold the ATT button to enter the front-end settings panel (more details in [ATT/PREAMP control](#)^{□156}).
- 8) **PA** - Control button for external power amplifiers in TX mode.
Short press the PA button to enable the external PA in TX mode.
Press and hold the PA button to enter the external PA settings panel (more details in [External PA control](#)^{□178}).
- 9) **ANT** - Antenna switch button.
Short press the ANT button for synchronous (receiving and transmitting) antenna switching.
Successive presses cycle through the antennas.
Press and hold the ANT button to enter the antenna switch settings panel (more details in [Antenna switching](#)^{□167}).
- 10) **USB** - Connectors for USB devices.
Connect the standard USB devices (mouse, keyboard, disk module and others) to these connectors.
The load current can be up to 500 mA.
- 11) **PHONES** - Jack for headphones.
Connect headphones with impedance of 8 ... 64 Ohm to the PHONES jack.
For example, a standard computer headset with a stereo jack connector.
- 12) **MIC 1** - Jack for electret microphones. Line-in.
Connect electret microphone to **MIC 1**, for example, the microphone of a standard computer headset.
The Jack can also be used as a standard line-in (more details in [Microphone \(Dynamic/Electret\)](#)^{□17}).

13) **MIC 2** - Jack for dynamic microphones.

Connect a dynamic microphone to **MIC 2** (e.g. the MD-15 accessory supplied with the transceiver).

The Input is designed for a microphone impedance of 400 ... 600 Ohm.

14) **F1...F10** - Functional assignable buttons.

Manage the functions assigned to the F1...F10 buttons (more details in [Functional buttons using](#)^{D170}).

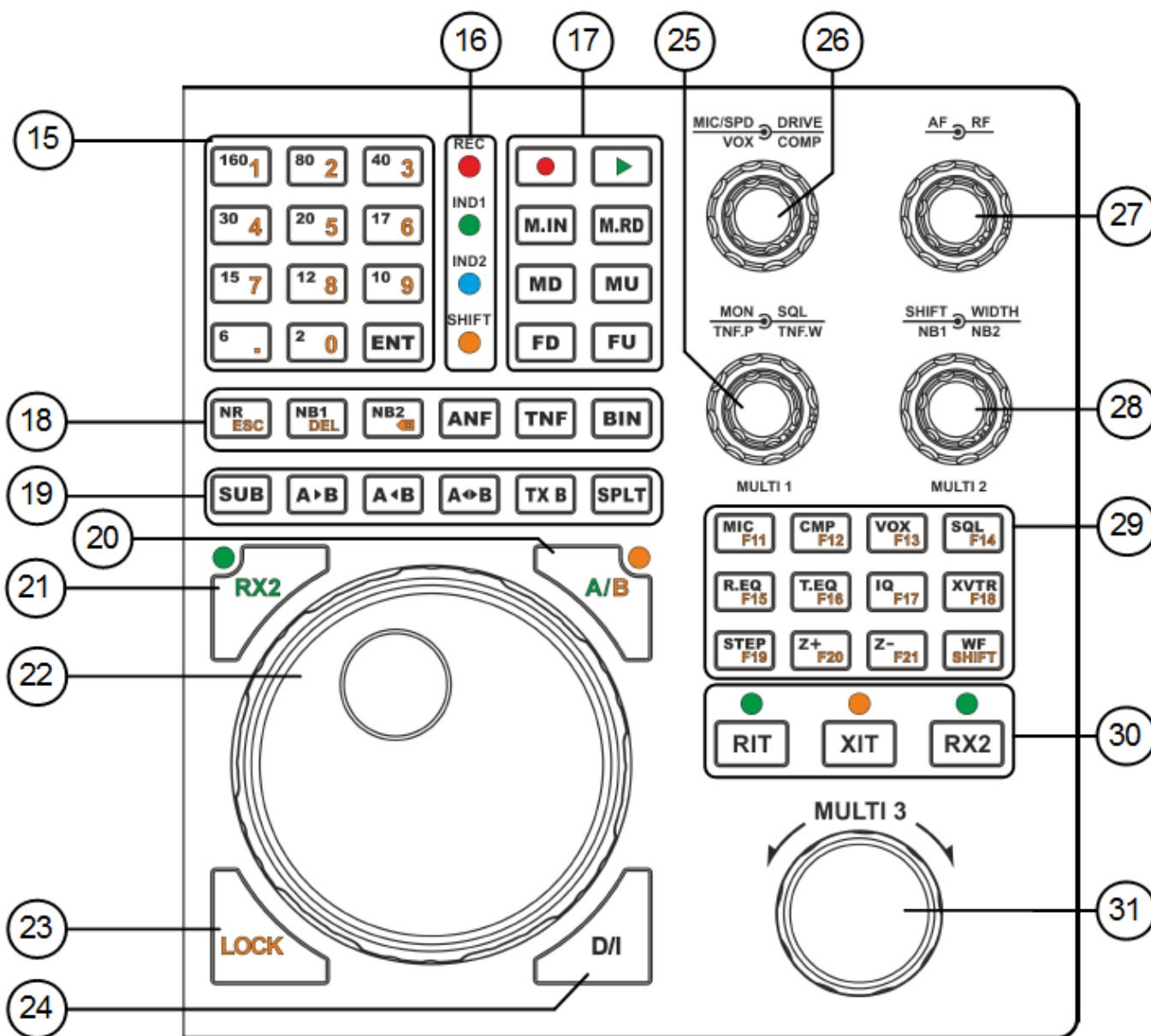

15) **160...2** - Band selection buttons.

Press the corresponding button to go to the desired band range.

Band buttons have a three position memory (more details in [Using the band memory](#)^{D153}).

ENT - The button starts and confirms manual frequency input.

Press ENT button to initialize manual frequency input.

Press again after the completion of input of the frequency.

1...0 - Buttons for manual frequency input.

Press required buttons to input the frequency.

16) **LED Indicators** - Transceiver mode indicators.

REC - Record mode indicator.

A Red LED shows when Record is active.

IND1 - D/I frequency tuning mode indicator.

A Green LED shows when the IF frequency tuning mode is active (more details in [Frequency Tuning](#)¹⁴⁷).

IND2 - Reserve indicator.

Currently Inactive.

SHIFT - Indicator of the buttons' second functions mode.

Indicator shines with orange light, when the buttons' second functions mode is active (more details in [Button SHIFT Operation](#)¹⁹¹).

17)  - Voice Recorder button.

Press the **REC** button to start recording the signal. Press again to stop recording (more details in [Voice Recorder Operation](#)¹⁷⁶).

While recording, the **REC** indicator will show on the transceiver's front panel.

Note:

 You can record received signals from the air, and also from your own microphone.

 Attention, recordings of the air signals should be used for personal use only. MB1 operator bears full responsibility for using the recorded signal .



- Button to play the Voice Recorder.

A short press of the **PLAY** button simultaneous plays and transmits the signal on air. After the transmitting the recording, the transceiver will switch to receive mode.

Press and hold **PLAY** button to play the recording without transmitting.

M.IN - Button to save the current frequency in memory.

Press **M.IN** button to save the frequency in transceiver's long-term memory.

M.RD - Button to recall the saved frequency from the memory.
Press the **M.RD** button to tune on the saved frequency.

MD - Button to switch modulation type Down the list.
Press the **MD** button to select the previous modulation type Down the list.
Press again to cycle through the modulation types.

MU - Button to switch modulation type Up the list.
Press the **MU** button to select the next modulation type Up the list.
Press again to cycle through the modulation types.

FD - Button to Reduce the band width of the receiver filter.
Press the **FD** button to select a narrower receiver band filter from the predefined set.
Press again to cycle through the filters.

FU - Button to Increase the band width of the receiver filter.
Press the **FU** button to select a wider receiver band filter from the predefined set.
Press again to cycle through the filters.

18) **NR** - Button to enable Noise Reduction.
Press the **NR** button to enable noise reduction of the receiver (more details in [DSP functions using \$\square^{164}\$](#)).

NB1 - The First Noise Blanker button for impulse interference.
Press **NB1** button to enable the first noise blanker for impulse interference.

NB2 - The Second Noise Blanker button for impulse interference.
Press **NB2** button to enable the second noise blanker for impulse interference.

Note:

 *The NB1 and NB2 algorithms are different. Try each of them to reach the best impulse interference reduction.*

 ***NB1** and **NB2** Noise Blankers can also be used simultaneously.*

ANF - Automatic Notch Filter button.

Press the **ANF** button for automatic reduction of the narrowband interference in the receiving band (interference, carrier signals, CW signals, etc.).

Note:

 If there are no interference, **ANF** could slightly affect the reception quality of the desired signal. Disable **ANF**, if you don't need it.

TNF - Tuning Notch Filter button.

Press the **TNF** button to enable a manual filter for reducing narrowband interference in the receiving band (interference, center frequencies, CW signals, etc.).

Using the **TNF.P** and **TNF.W** adjustment knobs, you can tune the TNF filter parameters (more details in [DSP functions using](#)¹⁶⁴).

BIN - Binaural audio mode button.

Press the **BIN** button to enable binaural audio mode. In one of the headphone channels, the signal will be shifted in phase.

19) **SUB** - Sub-receiver button.

Press the **SUB** button to enable the sub-receiver. Controlled via VFO B (more details in [Sub-receiver using](#)¹⁶⁸).

Note:

 Reception will function in the panorama's bandwidth.

A>B - Button to assign the frequency from heterodyne VFO A to heterodyne VFO B.

Press **A>B** button to assign the frequency from heterodyne VFO A to heterodyne VFO B (more details in [VFO A and VFO B control](#)¹⁵⁹).

A<B - Button to assign the frequency from heterodyne VFO B to heterodyne VFO A.

Press **A<B** button to assign the frequency from heterodyne VFO B to heterodyne VFO A (more details in [VFO A and VFO B control](#)¹⁵⁹).

A<>B - Button for frequency exchange between VFO A and VFO B.

Press **A<>B** to exchange the frequency values between VFO A and VFO B (more details in [VFO A and VFO B control](#)¹⁵⁹).

TX B - Button to activate Transmission mode in Sub-receiver.

Press **TX B** button to activate the transmission mode of Sub-receiver.

Press again **TX B** button to return the transmission mode to heterodyne VFO A.

SPLIT - Button to enable SPLIT.

Press the **SPLIT** button to activate reception mode on the separate frequencies (more details in [SPLIT Operation](#)¹⁸⁶).

20) **A/B** - Switch button of the Main knob between VFO A and VFO B.

Press the **A/B** button to switch on the control of the Main knob for VFO B.

The LED in the corner of this button indicates whether the mode is active.

Note:

 While the A/B mode is active, Multi 3 knob controls the heterodyne VFO A frequency.

21) **RX2** - Button to switch control of the Main knob from RX1 to RX2.

Press the **RX2** button to control second receiver via Main knob.

The LED in the corner of this button indicates whether the mode is active.

Note:

 The button will work only if the RX2 receiver is switched on. See 30th paragraph of this chapter, how to enable RX2 receiver.

22) **MAIN KNOB** - Main knob.

Rotate the Main knob to tune the receiver frequency.

You can control the VFO A and VFO B frequency of the first receiver, and the VFO A and VFO B frequency of the second receiver (more details in [Frequency tuning](#)¹⁴⁷).

23) **LOCK** - Button for locking the frequency.

Press the **LOCK** button to lock the frequency. This also blocks bands changes.

24) **D/I** - Button to switch between DDS/IF tuning modes.

Press the **D/I** button to enable frequency tuning according to IF.

The receiver's filter will move over the panorama and the stations will be fixed. IND1 indicates that IF mode is turned on.

Press the **D/I** button again to return to DDS tuning mode.

With that setting the receiver will fix its position and stations will move over panorama.

25) **DOUBLE KNOBS - MON, SQL, TNF.P, TNF.W, MULTI 1.**

MON - The monitor volume control knob.

Rotate the **MON** knob to adjust the monitor volume in transmission mode.

The knob will only be active in transmission mode and when pressed (more details in [Adjusting the Monitoring Gain](#)¹⁷⁵).

SQL - Squelch knob.

Rotate the **SQL** knob to set the required squelch level for the noise blanker.

It is convenient to control the squelch level using the S-meter yellow needle.

The knob will only be active when in SQL mode (more details in [Squelch level adjusting](#)¹⁶³).

TNF.P - Tunable Notch Filter Position.

Rotate the **TNF.P** knob to set the position of the tunable notch filter in the receiving filter band.

TNF.W - Tunable Notch Filter Width.

Rotate the **TNF.W** knob to set the required blocking band of the notch filter.

MULTI 1 - Knob for shifting the categories in local settings panels.

Rotate the **MULTI 1** knob to select the required settings category in the local settings panel on the transceiver's display.

Note:

 If the local settings panel is open, then **MON**, **TNF.P** will not be active.

Close the local settings panel to operate these functions.

26) DOUBLE KNOBS - MIC, SPD, DRIVE, VOX, COMP.

MIC - Knob for microphone input (in dB) gain control.

Rotate the **MIC** knob to set required level of microphone gain.

The microphone gain level is displayed in the software Main window (more details in [Microphone gain control](#)¹⁷²).

Note:

 The gain factor is stored for each microphone (**MIC 1**, **MIC 2**, **MIC PC**).

SPD - CW speed knob (in WPM).

Rotate the **SPD** (**SPEED**) knob to set the speed of the CW signal.

The knob will be active only in CW mode. The set speed is displayed in the software Main window (more details in [Transmitting in CW mode](#)¹⁸⁰).

DRIVE - Drive output knob (in %).

Rotate the **DRIVE** knob to set the transceiver's output power.

The level of output power displayed in % in the software Main window (more details in [DRIVE level adjusting](#)¹⁷¹).

VOX - VOX gain control knob.

Rotate the **VOX** knob to set the level of VOX gain.

The **VOX** knob is only active when the VOX mode is switched on (more details in [VOX operation](#)¹⁷⁵).

Note:

 *VOX - the transmitting mode is switched on automatically by speaking in the microphone (Voice-Operated Transmit).*

COMP - Compression level knob.

Rotate the **COMP** knob to adjust the compression level of the transmitting signal.

The knob is active only for speech modes SSB and AM (more details in [Compression level adjusting](#)¹⁷⁴).

Note:

 *The compression function increases the average output power, while decreases pick-factor of the transmitting signal.*

27) DOUBLE KNOBS - AF, RF.

AF - AF Gain knob (LF gain).

Rotate the **AF** knob to set the required volume level (more details in [Adjusting AF level](#)¹⁴⁹).

Note:

 *The AF knob controls the volume of all receivers (RX1, RX2, VFO A, VFO B). You can set the volume for each of them in the local panel of the audio mixer (more details in [Audio signals routing](#)¹⁵¹).*

RF - RF Gain knob (receiver's AGC gain level).

Rotate the **RF** knob to adjust receiver's AGC gain level.

With the AGC is switched off, the knob will set the RF gain (more details in [Adjusting the RF gain](#)¹⁵⁰).

28) DOUBLE KNOBS - SHIFT, WIDTH, NB1, NB2, MULTI 2.

SHIFT - Shift knob of the receiving filter.

Rotate the **SHIFT** knob to shift receiving filter relatively to the tuned frequency.

WIDTH - Width knob of the receiving filter.

Rotate the **WIDTH** knob for smooth tuning of the receiving filter width.

The receiving filter width changes with regard to the filter's center frequency.

NB1 - Noise Blanker 1 knob.

Rotate the **NB1** knob to tune the Noise Blanker 1 filter threshold (more details in [DSP Functions using](#)¹⁶⁴).

NB2 - Noise Blanker 2 knob.

Rotate the **NB2** knob to tune the Noise Blanker 2 filter threshold (more details in [DSP Functions using](#)¹⁶⁴).

MULTI 2 - Knob for adjusting parameters in the local settings panels.

Rotate the **MULTI 2** knob to choose the required settings category in the local settings panel on the transceiver's display.

Note:

 If the local settings panel is open, then **SHIFT**, **NB1** will not be active. Close the local settings panel to continue operation with these functions.

29) **MIC(CW)** - Switch button for microphone inputs. CW mode settings.

Press the **MIC** button to select the microphone input (MIC 1, MIC 2, MIC PC).

The selected microphone is displayed in the Main window (more details in [Choosing the microphones input](#)¹⁷²).

Press and hold the **MIC** button to open microphones' local settings panels.

(!) Press and hold the **MIC** button to open the CW mode local settings panels.

CMP - Speech signal compressor button.

Short press the **CMP** button to enable the speech signal compressor.

Press again to switch off the compressor.

Press and hold the **CMP** button to open compressor's local settings panel (more details in [Compression level adjusting](#)¹⁷⁴).

Note:

 The compression function is only available for SSB and AM modulation types.

VOX - Button for voice transmitting activation.

Short press the **VOX** button to enable the voice transmitting system.

Press and hold the **VOX** button to open VOX local settings panel (more details in [VOX operation](#)¹⁷⁵).

Note:

 The **VOX** - transmitting mode is switched on automatically by speaking (Voice-Operated Transmit).

SQL - Squelch button.

Press the **SQL** button to enable squelch.

Set the squelch threshold with the **SQL** knob on the transceiver's front panel (more details in [Squelch level adjusting](#)¹⁶³).

R.EQ - RX mode equalizer.

Short press the **R.EQ** button to enable the equalizer in RX mode.

Press and hold the **R.EQ** button to open the equalizer local settings panel for RX mode (more details in [Adjusting RX Equalizer](#)¹⁶³).

Note:

 Tune the equalizer via the touch screen panel (by touching and moving the sliders), or use the **MULTI1** and **MULTI2** knobs.

T.EQ - TX mode equalizer.

Short press the **T.EQ** button to enable the equalizer in TX mode.

Press and hold the **T.EQ** button to open the equalizer local settings panel for TX mode (more details in [Adjusting TX Equalizer](#)¹⁷⁶).

Note:

 Tune the equalizer via the touch screen panel (by touching and moving the sliders), or use the **MULTI1** and **MULTI2** knobs.

IQ - IQ-files record button.

Press the **IQ** button to record the whole bandwidth to file.

Record is mode indicated in the Main window (more details in [IQ-files recording](#)^[166]).

Attention!

① **Continuous recording of IQ-files, could lead to using all available free disk space on your PC!**

XVTR - Transverter mode button.

Short press the **XVTR** button to enable transverter mode.

Press and hold the **XVTR** button to open the transverter mode local settings panel.

Note:

☎ *Transverter mode is not yet supported by the current version of the software. We plan to add it in new versions of the software.*

STEP - Button to change the step of frequency shifting.

Press the **STEP** button to select the required step of frequency shifting. The current step size is displayed in the Main window.

In Auto mode, the transceiver will change the step size of its frequency shifting dependent on the speed used when tuning the knobs (more details in [Frequency Tuning STEP Changing](#)^[167]).

Z+ - Zoom in panorama.

Press **Z+** to zoom in the transceiver's panorama (more details in [ZOOM-In ZOOM-Out the graphics](#)^[162]).

Note:

☎ *Zoom in of the panorama is carried out relative to the blue triangle - zoom center marker.*

Z- - Zoom out panorama.

Press **Z-** to zoom out the transceiver's panorama (more details in [ZOOM-In ZOOM-Out the graphics](#)^[162]).

Note:

☎ *Zoom out of the panorama is carried out relative to the blue triangle - zoom center marker.*

WF - Wide Filter button in the receiver's input.

Press the **WF** button to enable a wide filter with a width 0...65 MHz (for HF) and 95...150 MHz (for VHF) (more details in [Front End Filters Switching](#)^{□166}).

Note:

 The **WF** button will not function when the wide filter auto-enable mode is switched on.

30) **RIT** - Independent fine tuning of the receiver.

Short press the **RIT** button to enable an offset of the receiver.

The offset of the receiver is adjusted with the **MULTI3** knob.

Press and hold the **RIT** button to return the offset to zero (more details in [RIT/XIT Operations](#)^{□189}).

XIT - Independent fine tuning of the transceiver.

Short press the **XIT** button to enable the transmitting offset of the transceiver.

Offset of the transceiver is adjusted with the **MULTI3** knob.

Press and hold the **XIT** button to return the offset to zero (more details in [RIT/XIT Operations](#)^{□189}).

RX2 - Button to enable the Second receiver.

Press the **RX2** button to enable the second receiver (more details in [RX2 Operation](#)^{□192}).

Adjusting the second receiver's frequency will be available when you press the **RX2** button (see section 21).

31) **MULTI 3** - Multifunctional transceiver knob.

Rotate the **MULTI3** knob for VFO B frequency shifting when in regular mode.

Rotate the **MULTI3** knob for VFO A frequency shifting when in A/B mode.

Rotate the **MULTI3** knob to change the frequency offset of the receiver when in RIT mode.

Rotate the **MULTI3** knob to change the frequency offset of the transceiver when in XIT mode.

4 REAR PANEL DESCRIPTION

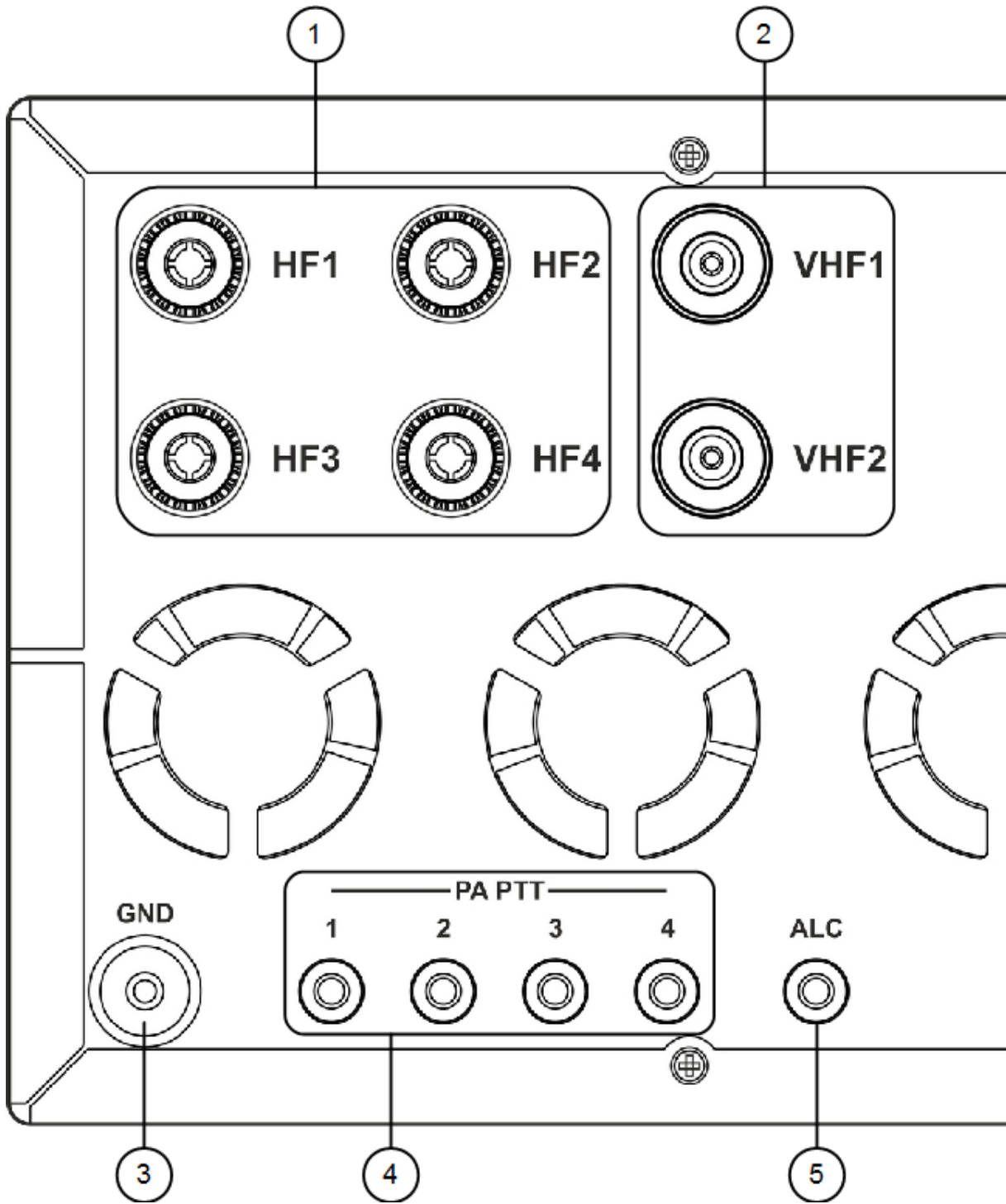

1) HF1-HF4 - HF antenna connectors.

Connect receiving and transmitting HF antennas to the **HF1-HF4** connectors. The antennas' impedance should be 50 Ohm.

You can select each of the antenna connectors using the **ANT** button on the front panel of the transceiver when in HF mode (more details in [Antenna switching](#)¹⁶⁷).

Note:

 Using an Antenna impedance different from 50 Ohm may lead to deterioration of the receiving capabilities of the transceiver and degradation of the quality of the transmitted signal.

2) VHF1-VHF2 - VHF antenna connectors.

Connect receiving and transmitting VHF antennas to the **VHF1-VHF** connectors. The antennas' impedance should be 50 Ohm.

You can select each of the antenna connectors using the **ANT** button on the front panel of the transceiver when in VHF mode (more details in [Antenna switching](#)¹⁶⁷).

Note:

 Using an Antenna impedance different from 50 Ohm may lead to deterioration of the receiving capabilities of the transceiver and degradation of the quality of the transmitted signal.

3) GND - Grounding/Earth terminal.

Use the **GND** terminal for grounding the transceiver.

Attention!

① **To eliminate the risk of electric shock, reliable grounding of transceiver is required!**

4) PA PTT 1-4 - PTT keys for external Power Amplifiers switching in TX mode.

Connect an external Power Amplifier to one of the **PA PTT** keys to allow the transceiver to switch the PA to transmitting mode (more details in [Linear Amplifier](#)²¹).

5) ALC - Automatic Level Control.

Connect to the **ALC** output of the Power Amplifier for automatic control of the transceiver output power.

Input voltage range 0...-4 V.

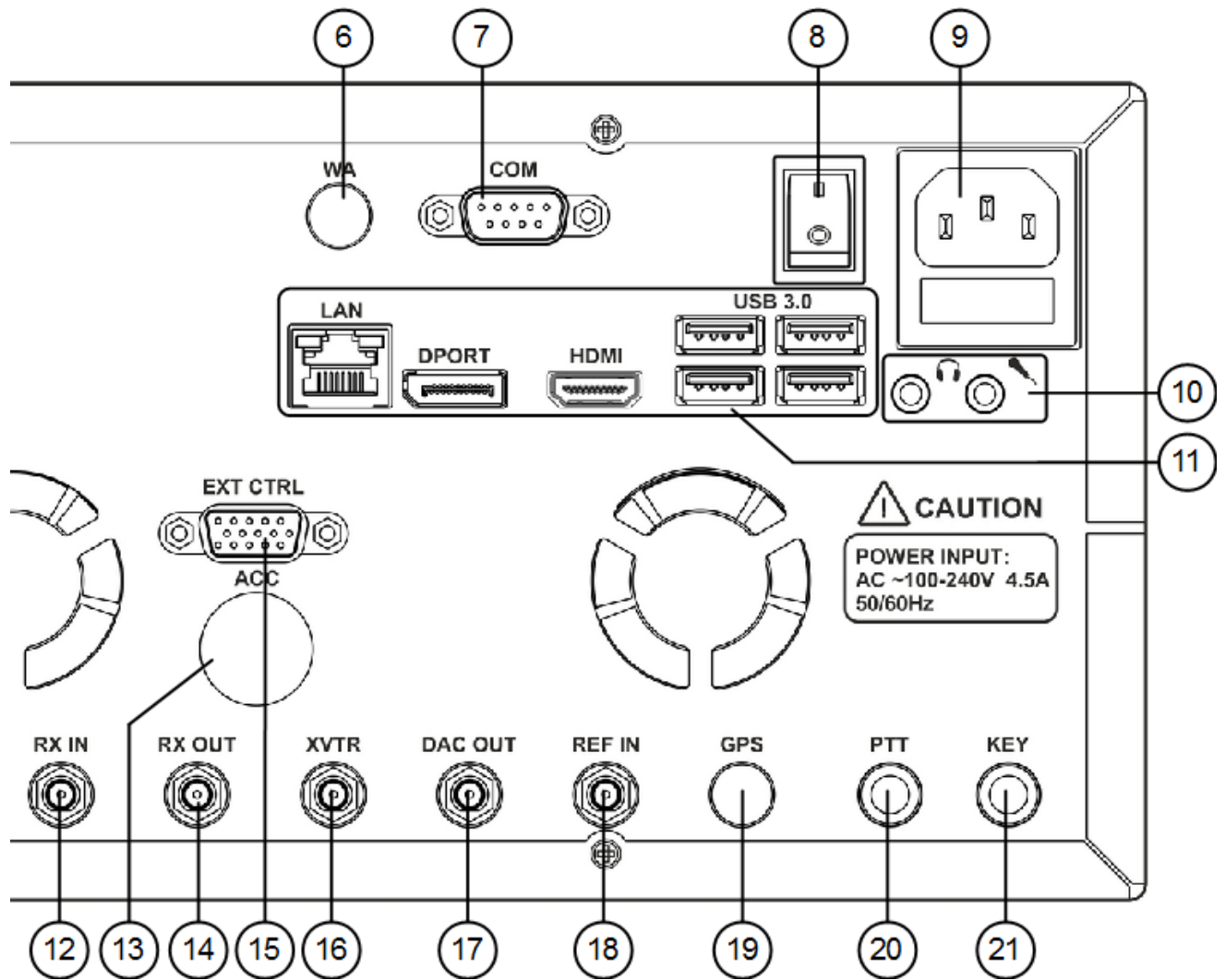

- 6) **WA** - Connector for embedded WLAN module.
Not available in this revision of the MB1.
- 7) **COM** - COM-port connector.
The **COM-port** connects to external devices to control them (more details [Rear-Panel](#))^{D19}.
- 8) **I/O** - Power switch
Select the **I** position to apply power to the transceiver.

Note:

Make sure that the rear power switch is in I position before pressing the power button on the front panel of the transceiver.

- 9) Transceiver's power connector.
Connect the transceiver to the AC mains using the cable from the kit.
The supply voltage range is 100-240 V. Frequency 50/60 Hz. Current up to 4.5 A.

There is a 5A fuse installed in the power connector.

10) **MIC** - PC microphone input. Linear audio input.

Connect a microphone to the microphone input of the internal PC or use it as a line-in input.

Headset - Headphone jack. Line-out audio output.

Connect headphones to the output or other devices which use an output audio signal.

11) PC connectors panel.

LAN - Internal PC Local Area Network card connector.

Connect the MB1 to local networks for remote operation of the MB1 and/or for internet access.

DPORT - Connector for an external monitor display (Display Port).

Connect an external monitor to extend the capabilities of your MB1.

HDMI - Connector for external monitor display.

Connect an external monitor display to extend the capabilities of your MB1.

Supports HDMI display with a resolution up to 4K.

USB 3.0 - Connectors for USB devices. Standard USB 3.0 or lower.

Connect to standard USB devices (mouse, keyboard, flash card, USB-COM-adaptor, printer and more.) to extend the capabilities of your MB1.

12) **RX IN** - Direct input of the receiver (high-speed ADC input).

Connections to the **RX IN** for receiving antennas, external filters, high-frequency amplifier, converters (more details in [RX IN and RX OUT](#)^{□26}).

13) **ACC** - Not active now.

14) **RX OUT** - RF output of the receive path.

Connections to the **RX OUT** for external filters, high-frequency amplifier etc. (more details in [RX IN and RX OUT](#)^{□26}).

15) **EXT CTRL** - Connector for external devices.

Connections to the **EXT CTRL** connector for an external power amplifier, antenna connector, band filter and control them ([EXT CTRL devices](#)^{□23}).

16) **XVTR** - Connector for an external transverter.

Connect to the **XVTR**, external transverters for UHF, SHF and other bands (more details in [XVTR](#)^{□25}).

17) **DAC OUT** - Linear output of the low power (up to 10 mW) signal generator.

Connect to the DAC OUT external power amplifiers, transverters (more details in [DAC OUT low power output](#)^{□25}).

Note:

 Signals can be generated on the amateur bands, in the frequency range 0.1-160 MHz.

18) **REF IN** - Input for an external reference frequency 10 MHz.

Connect to the **REF IN** an external reference oscillator with a 10 MHz frequency (more details in [Reference input](#)^{□24}).

19) **GPS** - Antenna input of the internal GPS receiver.

Not used in the current MB1 transceiver.

20) **PTT** - Jack for PTT footswitch.

Connect a PTT footswitch to the jack, for control when in TX mode.

21) **KEY** - Jack for CW key.

Connect a CW key to the KEY jack.

The key can be a twin-paddle or a single-paddle key or a classic straight key (more details in [Accessories](#)^{□19}).

5 MAIN SCREEN DESCRIPTION

There is a touch screen display on the front panel of the MB1. On the screen you can see the software main window. You can control the transceiver by manipulations with the software window on the touchscreen display.

5.1 Main Window

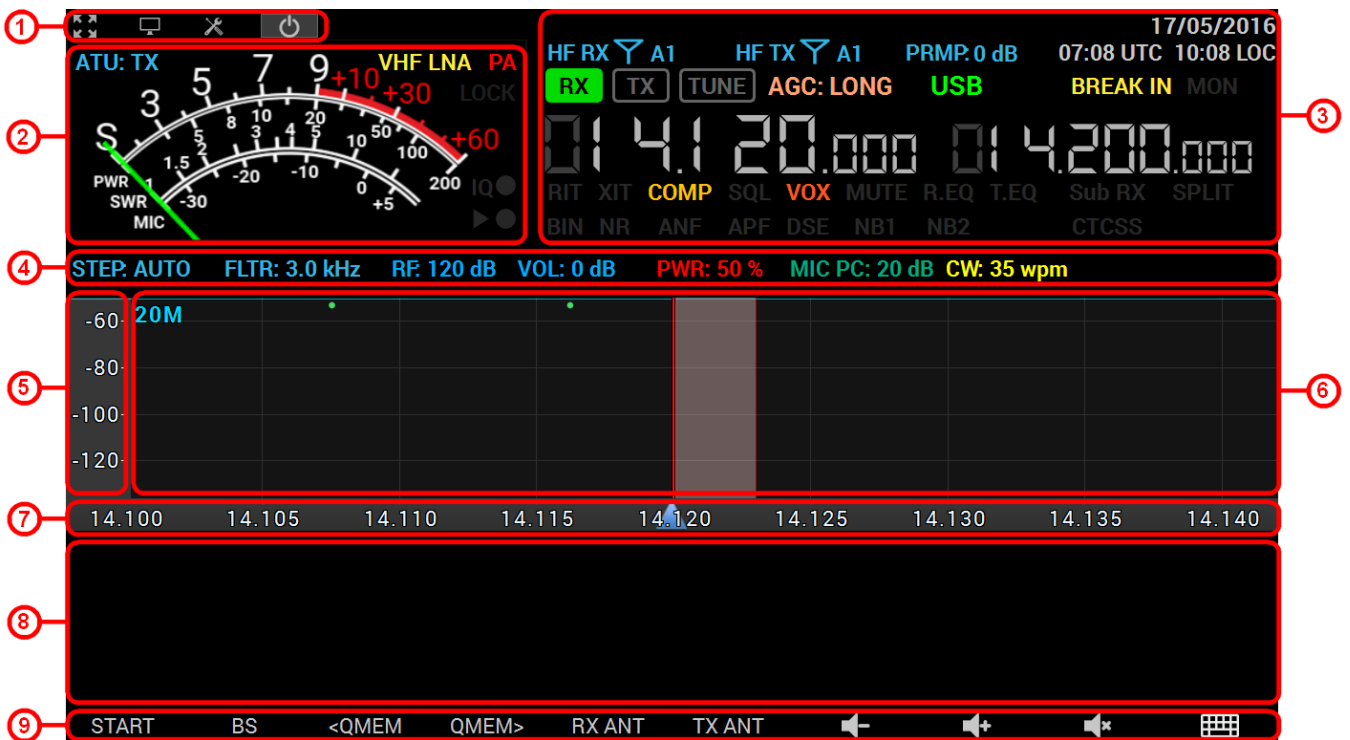

5.1.1 Section 1



- Full screen button.

Press the button to switch software main window to the full screen mode. Press again to disable full screen mode.



- Switch view button.

Press the button to change ExpertSDR2 to classic PC view. We recommend to use external display at least 19" for this view.



- Options button.

Press the button to open Options window.



- Start button.

Press the button to begin to listen to the air.

Note:

☎Auto-start is set by default after the launch of the software, no need to press the button.

5.1.2 Section 2

ATU: TX - Automatic Tuner Unit (ATU or Tuner) mode indicator.

ATU indicator shows current mode.

BPS - Bypass. Tuner is not used in TX and RX modes.

TX - TX mode. Tuner used in the TX mode.

RX - RX mode. Tuner used in the RX mode.

PA - PTT keys indicator.

If PA indicator shines with a red light, then PTT keys could be triggered in TX mode. For keys to trigger, they should be preliminary set up (more details in [External PA control](#)¹⁷⁸).

LOCK - Frequency tuning locked indicator.

If LOCK indicator shines with an orange light, then frequency tuning is impossible by any means (more details in [Frequency tuning LOCK](#)¹⁵⁹).

IQ - IQ-file record indicator.

If IQ indicator shines with a red light, then you record an IQ-file (more details in [IQ-files recording](#)¹⁶⁵).

Warning!

① **IQ-files may require a huge amount of space! Continuous recording of IQ-files, could lead to using all available free disk space on your PC!**

▶● - Voice recorder play/record indicator.

If record indicator (circle) shines with a red light, then you record a voice signal (more details in [Voice Recorder Operation](#)¹⁷⁶).

If play indicator (triangle) shines with a green light, then you play a voice signal.



- Signal level measurement.

Signal level indicator displays in different modes level of: received signals, transceivers output power, SWR, Mic signal (more details in [Meter](#)¹⁶⁵).

5.1.3 Section 3

HF RX A1 

- Indicator/RX antenna switch.

Indicates and allows you to choose the RX antenna (more details in [Antenna switching](#)¹⁶⁷).

HF TX A1 

- Indicator/TX antenna switch.

Indicates and allows you to choose the TX antenna (more details in [Antenna switching](#)¹⁶⁷).

PRMP: 0 dB

- Indicator/preamplifier switch.

Indicates and allows you to switch preamp value of the transceivers receive HF path (more details in [ATT_PREAMP control](#)¹⁵⁶).

17/05/2016

- Current date indicator.

Displays current system date in DD/MM/YYYY format.

07:08 UTC 10:08 LOC

- Current time indicator.

Displays current system time by the UTC and local standards.

RX

- Indicator/button to switch on RX mode.

If the indicator shines with a green light (as on the picture), then the MB1 transceiver is in the RX mode. If the transceiver is in any other mode, then the RX indicator will be dark-gray color.

Press the RX button with either the mouse cursor or via touch screen to turn the transceiver in the RX mode.

TX

- Indicator/button to switch on the TX mode.

If the indicator shines with a red light (as on the picture), then the MB1 transceiver is in the TX mode. If the transceiver is in the RX mode, by pressing the TX button with either the mouse cursor or via touch screen you'll turn it to the TX mode.

TUNE

- ATU indicator/button.

If the indicator shines with a red light (as on the picture), then the MB1 transceiver matching the transmitters output impedance with antennas impedance. To switch on/off this mode press the ATU indicator/button with either the mouse cursor or via touch screen.

AGC: LONG

- AGCs indicator/menu.

AGC indicator shows current AGC mode. Press this indicator/menu with either the mouse cursor or via touch screen to choose the required AGC mode (more details in [AGC presets](#)¹⁵⁷).

USB

- Modulation Indicator/menu.

USB indicator shows current modulation mode. Press this indicator/menu with either the mouse cursor or via touch screen to choose in the drop-down menu required modulation mode (more details in [Operating modes choosing](#)¹⁵⁴).

MON - TX monitor Indicator/menu.

MON indicator shines with a blue light if the monitor is enabled. Press this indicator/button with either the mouse cursor or via touch screen to enable/disable the monitor in TX mode. (more details in [Adjusting the Monitoring gain^{□175}](#)).

R.EQ - RX equalizer indicator/button.

R.EQ indicator shines with a green light if the RX equalizer is enabled. Press this indicator/button with either the mouse cursor or via touch screen to enable/disable RX equalizer (more details in [Adjusting RX equalizer^{□163}](#)).

T.EQ - TX equalizer indicator/button.

T.EQ indicator shines with a orange light if the TX equalizer is enabled. Press this indicator/button with either the mouse cursor or via touch screen to enable/disable TX equalizer (more details in [Adjusting TX equalizer^{□176}](#)).

 - First VFO A receiver frequency tuning indicator.

 - First VFO B receiver frequency tuning indicator.

RIT - RIT indicator/button (Receive Incremental Tuning).

RIT indicator shines with a blue light if the receiver offset is enabled. Press this indicator/button with either the mouse cursor or via touch screen to enable/disable receiver offset (more details in [RIT^{□189}](#)).

XIT - XIT indicator/button (Transmit Incremental Tuning).

XIT indicator shines with an red light if the transmitter offset is enabled. Press this indicator/button with either the mouse cursor or via touch screen to enable/disable transmitter offset (more details in [XIT^{□190}](#)).

COMP - Transmitter compressor indicator/button.

COMP indicator shines with a yellow light if the transmitter compressor is enabled. Press this indicator/button with either the mouse cursor or via touch screen to enable/disable transmitter compressor (more details in [Compression level adjusting^{□174}](#)).

MUTE - Mute indicator/button.

MUTE indicator shines with a green light if the receiver volume is disabled. Press this indicator/button with either the mouse cursor or via touch screen to enable/disable receiver volume (more details in [Muting the received audio^{□150}](#)).

SQL - Receiver squelch indicator/button.

SQL indicator shines with a yellow light if the receiver squelch is enabled. Press this indicator/button with either the mouse cursor or via touch screen to enable/disable receiver squelch. (more details in [Squelch level adjusting](#)¹⁶³).

VOX - VOX indicator/button.

VOX indicator shines with an orange light if the Voice-Operated Transmission is enabled. Press this indicator/button with either the mouse cursor or via touch screen to enable/disable Voice-Operated Transmission (more details in [VOX operation](#)¹⁷⁵).

Sub RX - Sub-receiver indicator/button.

Sub RX indicator shines with a green light if the sub-receiver is enabled. Press this indicator/button with either the mouse cursor or via touch screen to enable/disable sub-receiver (more details in [Sub-receiver using](#)¹⁸⁸).

SPLIT - SPLIT indicator/button.

SPLIT indicator shines with a red light if the split operation for the transmit frequency is enabled. Press this indicator/button with either the mouse cursor or via touch screen to enable/disable SPLIT (more details in [SPLIT operation](#)¹⁸⁶).

5.1.4 Section 4

STEP: AUTO - Frequency step indicator (more details in [Tuning STEP changing](#)¹⁶⁶).

FLTR: 3.0 kHz - Filter width indicator.

RF: 120 dB - Receiver AGC maximum gain.

PWR: 50 % - Output power level.

MIC PC: 20 dB - Current MIC and maximum gain indicator.

CW: 35 wpm - Speed of the CW signal being sent.

BIN - Receiver binaural audio indicator/button.

BIN indicator shines with a green light if the receiver binaural audio is enabled. Press this indicator/button with either the mouse cursor or via touch screen to enable/disable receiver binaural audio (more details in [DSP functions using](#)¹⁶⁴).

NR - Receiver Noise Reduction indicator/button.

NR indicator shines with an orange light if the receiver noise reduction is enabled. Press this indicator/button with either the mouse cursor or via touch screen to enable/disable receiver noise reduction (more details in [DSP functions using](#)¹⁶⁴).

ANF - Receiver Automatic Notch Filter indicator/button.

ANF indicator shines with a yellow light if the receiver automatic notch filter is enabled. Press this indicator/button with either the mouse cursor or via touch screen to enable/disable receiver automatic notch filter (more details in [DSP functions using \$\square^{164}\$](#)).

APF - Analog peak-filter indicator button. APF creates the triangle filter's AFC (amplitude-frequency characteristic) in the filter bandpass.

APF indicator shines with a green light if the analog peak-filter is enabled. Press this indicator/button with either the mouse cursor or via touch screen to enable/disable analog peak-filter (more details in [DSP functions using \$\square^{164}\$](#)).

DSE - Digital Surround Effect for CW signals indicator button.

DSE indicator shines with a blue light if the digital surround effect is enabled. Press this indicator/button with either the mouse cursor or via touch screen to enable/disable digital surround effect (more details in [DSP functions using \$\square^{164}\$](#)).

NB1 - Receiver Noise Blanker indicator/button.

NB1 indicator shines with a yellow light if the receiver noise blanker is enabled. Press this indicator/button with either the mouse cursor or via touch screen to enable/disable receiver noise blanker (more details in [DSP functions using \$\square^{164}\$](#)).

NB2 - Receiver Noise Blanker indicator/button (different from the NB1).

NB2 indicator shines with a yellow light if the receiver noise blanker is enabled. Press this indicator/button with either the mouse cursor or via touch screen to enable/disable receiver noise blanker (more details in [DSP functions using \$\square^{164}\$](#)).

5.1.5 Section 5

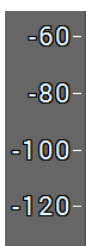

- Signal level scale, dBm for the RX mode and dBV for the TX mode.

5.1.6 Section 6



Transceiver's spectrum scope window. In this window you can see specter of the receiving/transmitting signals: Amplitude - vertical, Frequency - horizontal.

20M - Amateur band indicator.

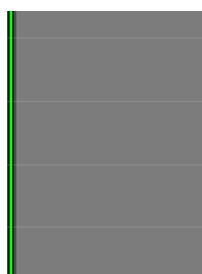

- Filter width is semitransparent. Vertical green line is a set frequency.

5.1.7 Section 7



Frequency scale.



- Spectrum scope zoom point marker.

Spectrum scope and waterfall are zoomed in or out in respect to this marker. (more details in [ZOOM-in ZOOM-out the graphics](#)^[162]).

5.1.8 Section 8

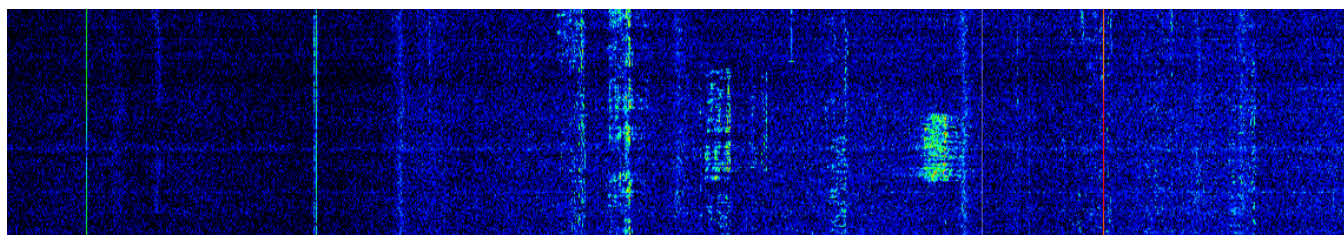

Waterfall graphic - Timed spectrum scope in format: Amplitude - Brightness, frequency - horizontal, time - vertical.

5.1.9 Section 9



F1-F10 settings panel (more details in [Functional buttons using](#)^[170]).

5.2 Local panels

Local panels display the main transceiver settings.

Press and hold the related button on the transceivers panel to call up a local panel, it will be displayed instead of the waterfall graphic.

To close a local panel press and hold the related button again or close it by the click on the cross in the right, top corner of the local panel with either the mouse cursor or via touch screen.

Note:

 Local panels are available only in the ExpertSDR2-MB1 style. In classic ExpertSDR2-PC style the local panels are not available. Required settings you may find in the Options menu.

5.2.1 ATU

Press and hold the **TUN** button on the front panel of the transceiver to open/close the local panel.

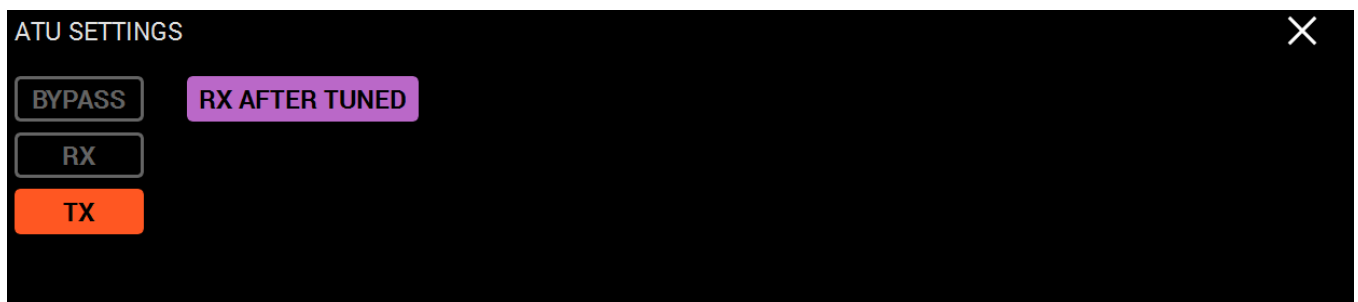

BYPASS - The tuner's Bypass mode button.

Press the **BYPASS** to enable tuner's bypass mode to exclude it's influence on the transceiver.

RX - Enable the Tuner for the RX mode.

Press the **RX** button to enable matching in the RX mode.

Note:

 The Tuner cannot do matching in the RX mode. The Tuner can only use saved earlier states from the TX mode.

TX - Enable the Tuner for the TX mode.

Press the **TX** button to enable matching in the TX mode (more details in [ATU operation](#)¹⁸⁴).

RX AFTER TUNED - "RX after tuned" enable button.

Press the **RX AFTER TUNED** button and the transceiver will turn to the RX mode after the tuner is tuned.

5.2.2 MIXER

Press and hold the **MUT** button on the front panel of the transceiver to open/close the local panel.

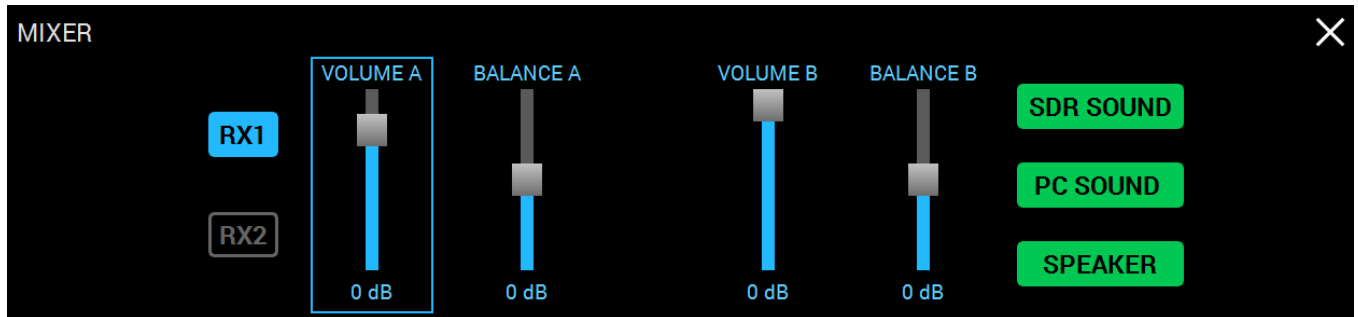

RX1 - Enable RX1 volume and balance controls.

Press the **RX1** to enable volume and balance control for VFO A, VFO B of the RX1.

RX2 - Enable RX2 volume and balance controls.

Press the **RX2** to enable volume and balance control for VFO A, VFO B of the RX2.

VOLUME A - VFO A volume control.

BALANCE A - VFO A volume balance control between left and right channels.

VOLUME B - VFO B volume control.

BALANCE B - VFO B volume balance control between left and right channels.

Note:

 Described above volume and balance settings are active when the sub-receiver is active. If you use only VFO A (the sub-receiver is disabled) the global volume control is active.

SDR SOUND - Audio output from the transceiver.

Press the **SDR SOUND** to listen to the transceiver's received signals.

PC SOUND - Audio output from the PC.

Press the **PC SOUND** to listen to the audio from PC, e.g. audio, video files, web browsing, SKYPE etc.

SPEAKER - Audio output to the speaker.

Press the **SPEAKER** to listen to the audio via the speaker.

Note:

 Audio output to the speaker is only available with the active **SPEAKER** button, in this menu. It doesn't matter whether the headphones are plugged in the **PHONES** jack or not.

 There is a constant audio output to the phones via **PHONES** jack, **SPEAKER** button state doesn't matter.

5.2.3 FRONT END SETTINGS

Press and hold the **ATT** or **ANT** button on the front panel of the transceiver to open/close the local panel.

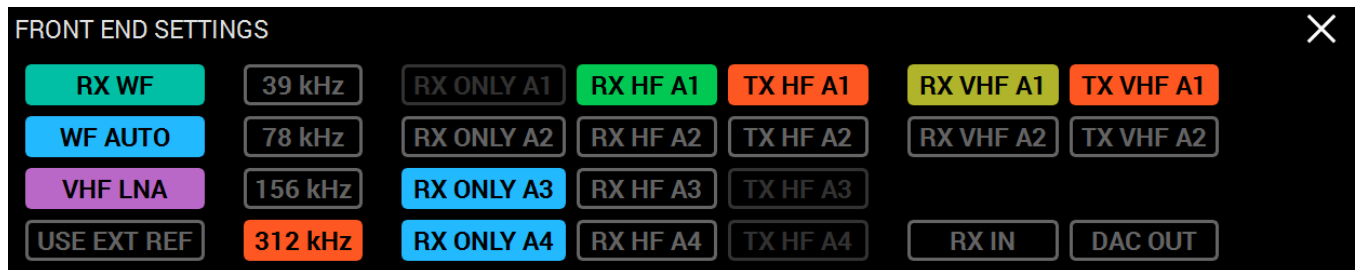

RX WF - The Wide Filter button.

Press the **RX WF** to enable Wide Filter for the whole HF (0...65 MHz) or VHF (95...155 MHz) band.

WF AUTO - Auto enable the Wide Filter.

Press the **WF AUTO** to switch on auto enable of the Wide Filter when the band-scope and/or the second receiver on the other band are switched on.

VHF LNA - VHF LNA button.

Press the **VHF LNA** button to enable Low Noise Amplifier for the VHF band. Auto disable when turn to HF band.

USE EXT REF - REF input enable button.

Press the **USE EXT REF** button to use 10 MHz external oscillator as the reference oscillator, to improve frequency stability.

Receiver's sample rate:

39 kHz - 39 kHz sample rate button.

78 kHz - 78 kHz sample rate button.

156 kHz - 156 kHz sample rate button.

312 kHz - 312 kHz sample rate button.

Receiver's sample rate influences panorama's bandwidth and quadrature's bandwidth, which could be transferred to the CW Skimmer.

RX ONLY A1...A4 - "RX only" mode buttons for the HF antennas.

Press the **RX ONLY Ax** button opposite to the required antenna input. Chosen antenna input will be used only for RX, you won't be able to transmit via it.

RX HF A1...A4 - Receive antenna buttons for the HF band.

Press the **RX HF Ax** button to choose receive antenna for the HF band (more details in [Antenna switching](#)¹⁶⁷).

TX HF A1...A4 - Transmit antenna buttons for the HF band.

Press the **TX HF Ax** button to choose transmit antenna for the HF band (more details in [Antenna switching](#)¹⁶⁷).

RX VHF A1..A2 - Receive antenna buttons for the VHF band.

Press the **RX VHF Ax** button to choose receive antenna for the VHF band (more details in [Antenna switching](#)^[167]).

TX VHF A1..A2 - Transmit antenna buttons for the VHF band.

Press the **TX VHF Ax** button to choose transmit antenna for the VHF band (more details in [Antenna switching](#)^[167]).

RX IN - Receiver direct input button.

Press the **RX IN** button to enable receiver direct input RX IN.

RX IN input will be connected to the ADC input by-passing band filters (more details in [Using RX IN input](#)^[169]).

When you enable RX IN you automatically disable RX OUT (more details [Using RX OUT output](#)^[169]).

DAC OUT - 10 mW low-power output button.

Press the DAC OUT button to enable transceiver low-power output. Low-power output frequency range is 100 kHz-160 MHz (more details in [DAC OUT operation](#)^[180]).

5.2.4 NFM-SETTINGS

Press and hold the **MD** or **MU** mode button on the front panel of the transceiver to open/close the local panel.

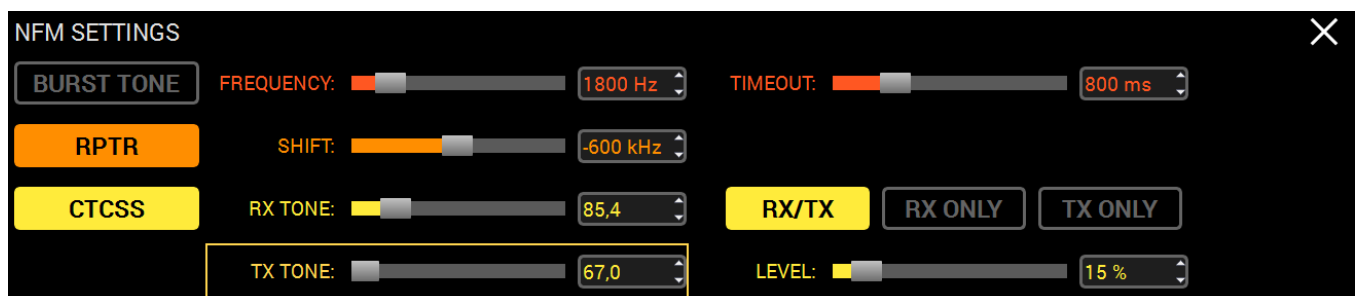

BURST TONE - Repeater tone TX button.

Press the **BURST TONE** button to transmit tone on air, which will open the repeater - "wake it up".

FREQUENCY - Tone frequency slider.

Set the tone frequency with the **FREQUENCY** slider or enter the required number from the keyboard in the input box.

TIMEOUT - TX tone timeout.

Set the required timeout to transmit tone with the **TIMEOUT** slider.

RPTR - Repeater mode button.

Press the **RPTR** button to enable repeater mode.

SHIFT - Repeater shift slider.

Set the frequency shift with the **SHIFT** slider or enter the required number from the keyboard in the input box.

CTCSS - CTCSS tone mode button.

Press the **CTCSS** button to enable the CTCSS tone mode.

RX TONE - CTCSS tone RX frequency slider.

Set the RX tone frequency with the **RX TONE** slider or enter the required number from the keyboard in the input box.

TX TONE - CTCSS tone TX frequency slider.

Set the TX tone frequency with the **TX TONE** slider or enter the required number from the keyboard in the input box.

RX/TX - CTCSS mode for both RX and TX.

Press the **RX/TX** button to enable CTCSS tone for both RX and TX.

RX ONLY - CTCSS mode only for RX.

Press the **RX ONLY** button to enable CTCSS tone for both RX.

TX ONLY - CTCSS mode only for TX.

Press the **TX ONLY** button to enable CTCSS tone for both TX.

LEVEL - Tone level slider.

Set the CTCSS tone level with the **LEVEL** slider or enter the required number from the keyboard in the input box. By default 15%.

5.2.5 DSP SETTINGS

Press and hold the **DSP** button on the front panel of the transceiver to open/close the local panel.

List of buttons on the front panel to open DSP local panel: **NR**, **ANF**, **TNF**, **BIN**, **NB1**, **NB2**.

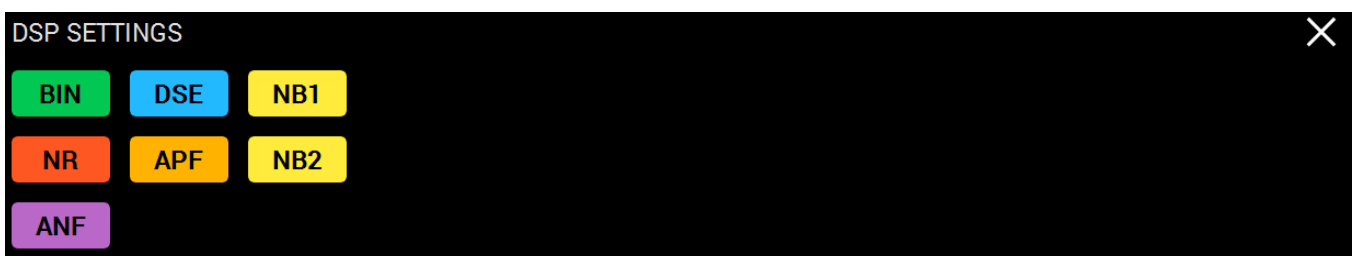

BIN - Binaural mode button.

Press the **BIN** button to enable binaural mode. In one of the headphone channels, the signal will be shifted in phase.

NR - Noise reduction button.

Press the **NR** button to enable receiver's noise reduction (more details in [DSP functions](#)¹⁶⁴).

ANF - Automatic Notch Filter button.

Press the **ANF** button to enable automatic reduction of the narrowband noises in the filter bandwidth (noises, carriers, CW signals etc.).

Note:

 If there are no interference, **ANF** could slightly affect the reception quality of the desired signal. Disable **ANF**, if you don't need it.

DSE - Digital Surround Effect in CW mode.

Press the **DSE** button to enable Digital Surround Effect (more details in [DSP functions](#)¹⁶⁴).

APF - Analog Pick Filter button. Analog peak-filter creates the triangle filter's AFC (amplitude-frequency characteristic) in the filter bandpass.

Press the **APF** button to enable Analog Pick Filter (more details in [DSP functions](#)¹⁶⁴).

NB1 - First Noise Blanker button.

Press the **NB1** button to enable the first Noise Blanker (more details in [DSP functions](#)¹⁶⁴).

NB2 - Second Noise Blanker button.

Press the **NB2** button to enable the second Noise Blanker (more details in [DSP functions](#)¹⁶⁴).

Note:

 The **NB1** and **NB2** algorithms are different. Try each of them to reach the best impulse interference reduction.

 **NB1** and **NB2** Noise Blankers can also be used simultaneously.

5.2.6 PA SETTINGS

Note:

 Will be available in the new software releases.

5.2.7 MIC/CW SETTINGS

Press and hold the **MIC** button on the front panel of the transceiver to open/close the local panel.

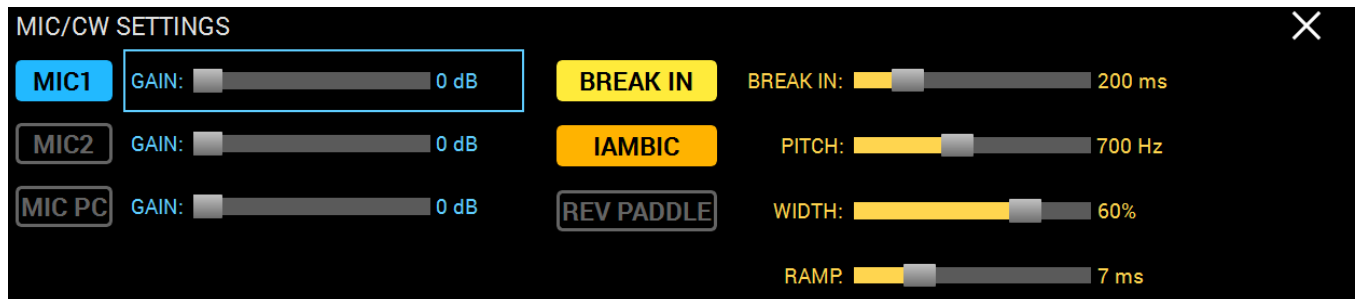

MIC1 - MIC 1 button.

Press the **MIC1** button to choose corresponding microphone.

MIC1 GAIN - Microphone input gain control.

Set the required gain level of the microphone input. Control sets the max microphone's AGC gain, while the microphone AGC is active.

MIC2 - MIC 2 button.

Press the **MIC2** button to choose corresponding microphone.

MIC2 GAIN - Microphone input gain control.

Set the required gain level of the microphone input. Control sets the max microphone's AGC gain, while the microphone AGC is active.

MIC PC - PC's sound card MIC.

Press the **MIC PC** button to choose PC's microphone.

MIC PC GAIN - Microphone input gain control.

Set the required gain level of the microphone input. Control sets the max microphone's AGC gain, while the microphone AGC is active.

BREAK IN - CW VOX mode.

Press the **BREAK IN** button to enable this mode - transceiver will automatically turn to the TX mode by the press on the CW keyer.

IAMBIC - Automatic dots and dashes generation.

Press the **IAMBIC** button to enable auto generation of the CW signal.

If the **IAMBIC** mode is off, while you press the CW keyer it will generate tone signal with PITCH frequency.

REV PADDLE - Dots and dashes reverse switch.

Press the **REV PADDLE** button to switch dots and dashes in reverse order on your CW keyer.

BREAK IN DELAY(ms) - Timing control, to keep the transceiver in the TX mode.

Set the required time for the transceiver to hold in the TX mode, after you let go of the CW keyer.

PITCH(Hz) - CW signal's frequency tone control.

Set the required CW signal's frequency tone (also used for the RX mode).

WIDTH(%) - Dot to Dash ratio control.

Set the required Dot to Dash ratio.

RAMP(ms) - CW signals' slope length control.

Set the required CW signals' slope length.

The higher manipulation speed the shorter should be slopes.

5.2.8 VOX/COMPRESSOR SETTINGS

Press and hold the **CMP/VOX** button on the front panel of the transceiver to open/close the local panel.

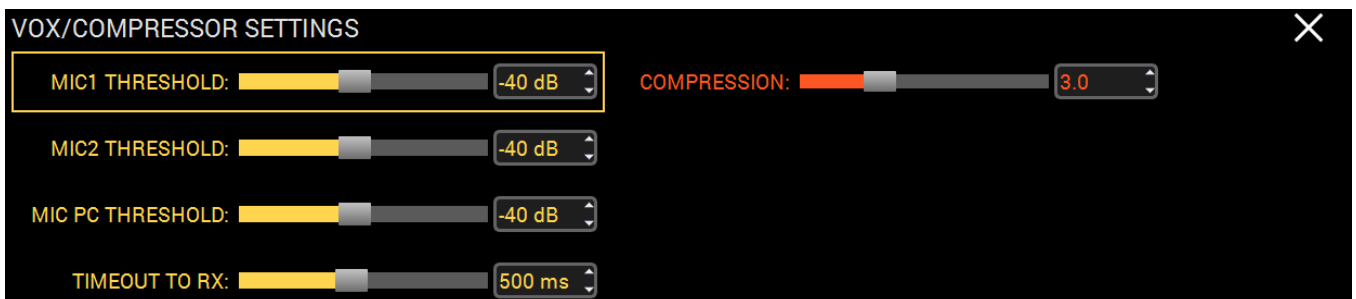

MIC1 THRESHOLD, MIC2 THRESHOLD, MIC PC THRESHOLD - VOX system operating threshold control, separately for each MIC input.

Set the VOX operating threshold for the corresponding microphone according to the noise level in the room (more details in [VOX operation](#)¹⁷⁵).

TIMEOUT TO RX - Delay control to switch from the TX mode to the RX mode after the VOX is off.

Set the required delay time to switch from TX to RX for comfortable operation on the air (more details in [VOX operation](#)¹⁷⁵).

COMPRESSION - Compression of the transmitted signal.

Set the required compression level for the transmitted signal (more details in [Compression level adjusting](#)¹⁷⁴).

5.2.9 RX EQUALIZER

Press and hold the **R.EQ** button on the front panel of the transceiver to open/close the local panel.

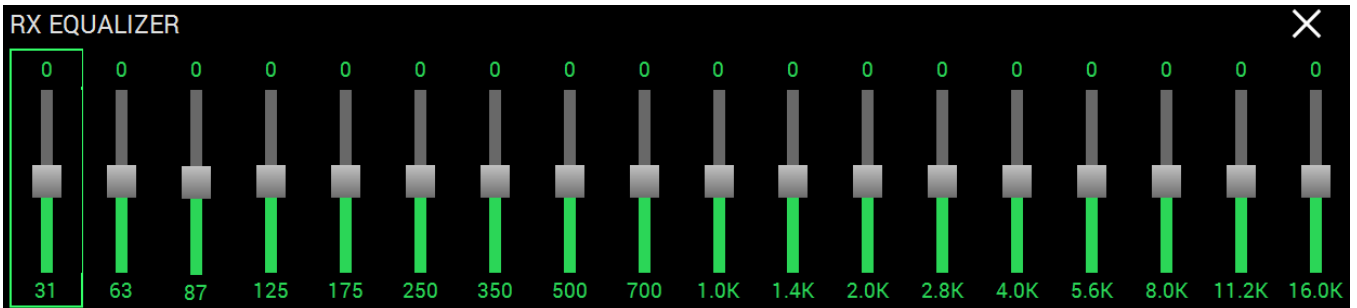

Set the required response for each RX equalizer frequency.

5.2.10 TX EQUALIZER

Press and hold the **T.EQ** button on the front panel of the transceiver to open/close the local panel.

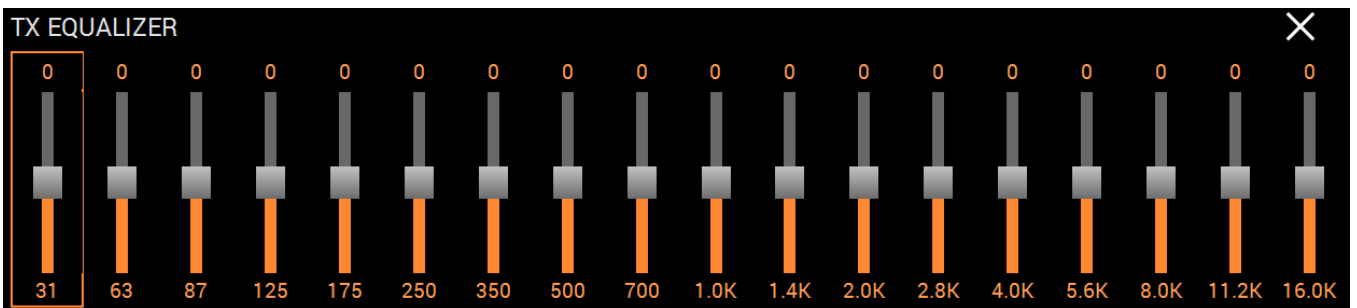

Set the required response for each TX equalizer frequency.



Note:

 TX equalizer settings are saved for each microphone separately.

5.3 Options

Fine tuning of the MB1 is carried out in the **Options** menu. You can call up the menu by pressing this button  in the software main window.

Note:

-  If you changed anything in the menu and you don't like it, but you forgot the default value, you can reset all setting to the default level by simply clicking the **Default** button. The same goes to some inclosed menus, where the **Default** button is present.
-  You can check the changes without leaving the **Options** window, just click the **Apply** button.
-  If you are satisfied with the changes and don't want to change anything else, click the **OK** button to close **Options** window.

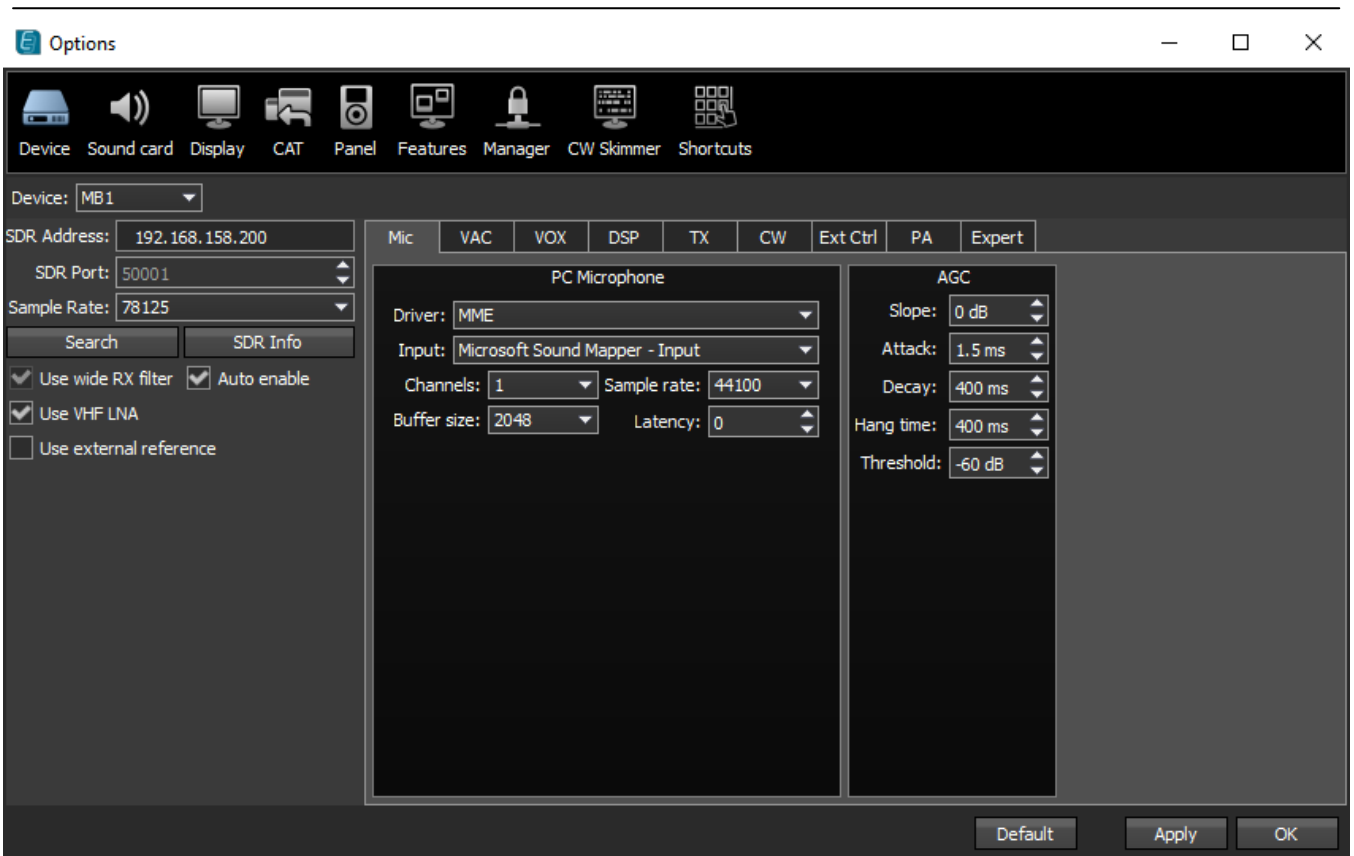

5.3.1 Device menu

There are software functions of the signal processing and hardware settings in the **Device** menu.

5.3.1.1 Device settings

The left part of the **Device** menu is for the main system functions of communications between the transceiver's software and hardware.

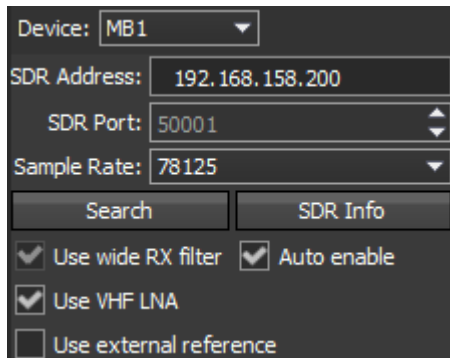

- **Device** - Transceiver type menu.
Shows that the ExpertSDR2 software works in the MB1 mode.
- **SDR Address** - Physical IP-address of the MB1 transceiver, 192.168.158.200 by default.
This setting cannot be changed.
- **SDR Port** - Port number, which used for the data exchange, 50001 by default.
This setting cannot be changed.
- **Sample Rate** - IF sample rate, equals the panorama bandwidth.
You can choose one of four panorama bandwidth values.

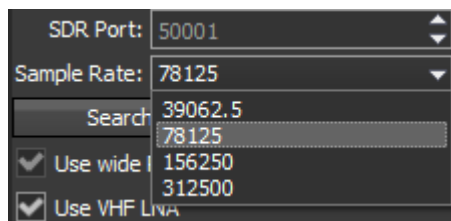

- **Search** - Search the device in the local network.
When you press the **Search** button, software searches for the SDR-transceivers in the network.
- **SDR Info** - Button to show you the transceiver serial number, firmware revision, PCB revision and set options.
You can use this button to test the connection between the software and transceiver. If the connection is successfully setup - you'll see the transceiver's info, if not - nothing will show up.

- **Use RX Wide filter** - Wide band filter checkbox.
Set the **Use RX Wide filter** checkbox to enable wide filter for the whole HF (0...65 MHz) or VHF (95...155 MHz) band.
- **Auto enable** - Auto enable RX WF checkbox.
Set the **Auto enable** checkbox to auto enable RX WF when the band-scope and/or the second receiver on the other band are switched on.
- **VHF LNA** - VHF LNA checkbox.
Set the **VHF LNA** checkbox to auto enable Low Noise Amplifier for the VHF band.
- **Use external reference** - REF input enable checkbox.
Set the **Use external reference** checkbox to enable REF input on the rear panel of the transceiver and use it as reference input.

5.3.1.2 Mic

There are two microphone settings categories in the **Mic** tab: **PC Microphone**, **AGC**.

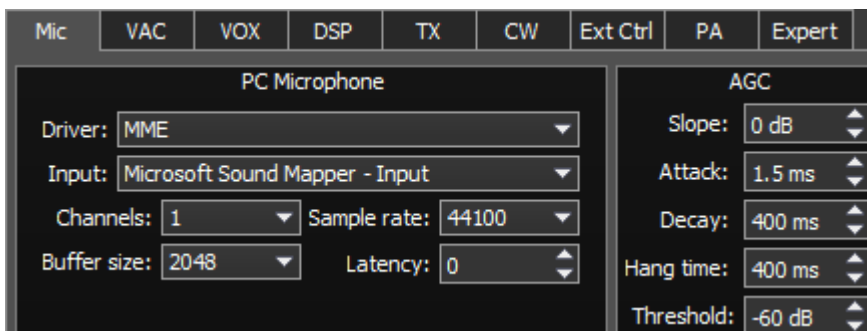

In the **PC Microphone** category you can adjust the internal PC's sound card, which is connected to the microphone.

PC Microphone category consists of the following items:

- **Driver** - choose the sound card's driver type.
- **Input** - choose the sound card's physical input.
- **Channels** - choose the amount of the sound card's used channels.
- **Sample rate** - sampling frequency.
- **Buffer size** - buffer size.
- **Latency** - signal delay time.

In the **AGC** category you can adjust the microphone's AGC. This settings influences both types of microphones.

AGC category consists of the following items:

- **Slope** - set the slope of the transfer characteristic.
- **Attack** - when a signal gets stronger, this value determines how quickly the AGC will decrease gain.
- **Decay** - when a signal gets weaker, this value determines how quickly the AGC will increase

gain.

- **Hang time** - signal recovery time.
- **Threshold** - AGC trigger threshold.

5.3.1.3 VAC

On the VAC tab you can see the settings of the audio device, which is used for operating with digital modes.

For each program receiver (RX1, RX2) you can set the virtual audio cable on the corresponding tab **Receiver 1** and **Receiver 2**.

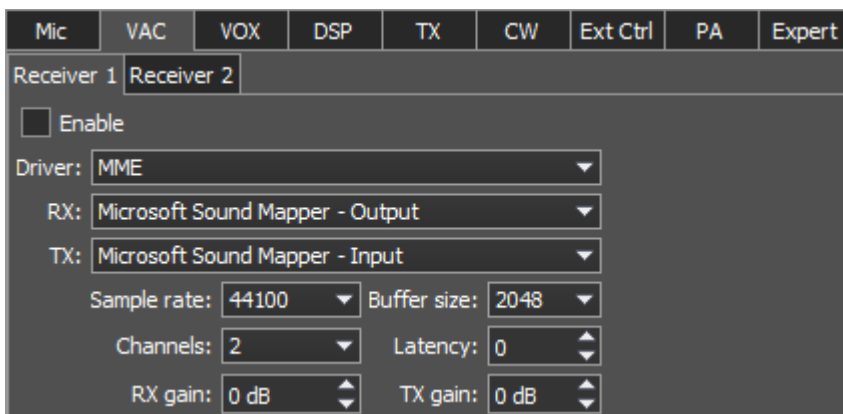

Enable - Enable virtual audio cable checkbox.

Set the **Enable** checkbox to enable virtual audio cable.

VAC category consists of the following items:

- **Driver** - choose the audio cable's or sound card driver type.
- **Input** - choose the sound card's physical input or the virtual audio cable's number.
- **Channels** - choose the amount of the sound card's or virtual audio cable used channels.
- **Sample rate** - sampling frequency.
- **Buffer size** - buffer size.
- **Latency** - signal delay time.
- **RX gain** - additional signal amplifying in the virtual audio cable's RX path in dB.

- **TX gain** - additional signal amplifying in the virtual audio cable's TX path in dB.

More details on the digital modes functionality you can see here [Transmitting in Digital mode](#)¹⁹¹.

Note:

- 📞 Before enable the **VAC**, make sure all settings for audio devices are correct.
 - 📞 If transceiver's ExpertSDR2 and digital modes software works on the same PC, you can connect them via the virtual audio cable, mentioned in this settings.
 - 📞 If the digital modes software works on the external PC, then in **VAC** settings you should set the internal MB1 sound card.
-

5.3.1.4 VOX

On the **VOX** tab you can see the settings of the Voice-Operated Transmit system.

VOX system triggers when the microphones voice signal exceeds the Threshold. Threshold could be set for each microphone individually.



VOX enable - VOX system enable checkbox.

Set the **VOX enable** checkbox to enable VOX system.

- **Timeout to RX** - VOX delay time to switch from the TX mode to the RX mode.
- **Threshold** - VOX trigger threshold.

5.3.1.5 DSP

On the **DSP** tab you can see the AGC's and Digital Signals Processing settings.

There are two types of settings in the drop-down menu:

- **AGC** - receiver's AGC settings.
- **DSP** - digital processing filter's settings.

Receiver's AGC settings.

There you can find fine AGC settings. AGC settings are divided by the processing speed on **Long, Slow, Med, Fast** and **User**.

Each settings type has its own tab and differs from others in terms of Attack, Decay and Hang time.

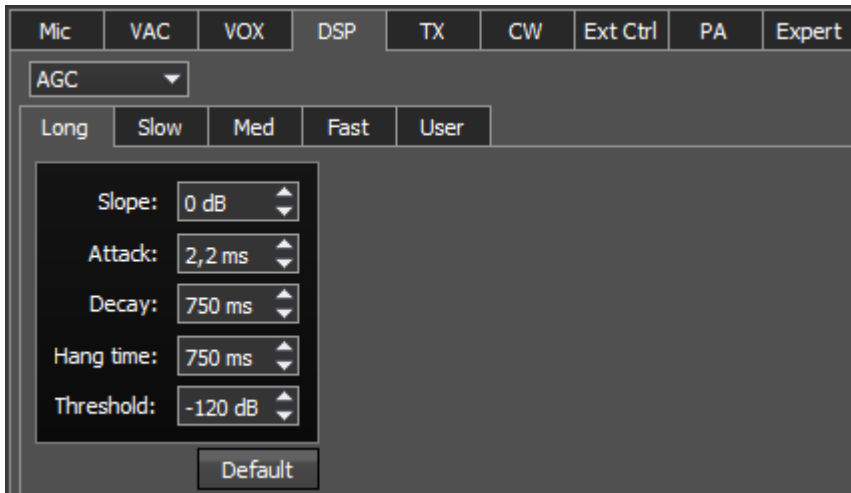

AGC parameters:

- **Slope** - set the slope of the transfer characteristic.
- **Attack** - when a signal gets stronger, this value determines how quickly the AGC will decrease gain.
- **Decay** - when a signal gets weaker, this value determines how quickly the AGC will increase gain.
- **Hang time** - signal recovery time.
- **Threshold** - AGC trigger threshold.

Default - reset AGC setting to the default level.

Press the **Default** button if you set wrong AGC values and don't like the result. Each AGC tab has a **Default** button.

Digital processing filter's settings.

There you can find fine the settings of the receiver's digital processing filters.

DSP functions clears the signal from abnormal noises and crosstalk.

These are the standard functions:

- **ANF** - Auto Notch filter, removes the carrier signals. This is a special adaptive filter, which removes any periodical signals from the air in the RX filter band.
- **NR** - Noise Reduction, removes the white noise. This is a special adaptive filter, which removes any abnormal noises from the air in the RX filter band.
- **NB** - Noise Blanker, removes impulse interference.
- **APF** - Analog peak-filter for CW mode. Provides a more comfortable listening of the CW signals by amplifying the CW signal in the center of the receive filter (triangle filter's AFC (amplitude-frequency characteristic) in the filter bandpass).

- **DSE** - Digital Surround Effect for CW signals. Provides a space orientation in stereo phones, stations from lower frequencies are louder in the left channel, stations from higher frequencies are louder in the right channel. Signal in the filter's center is equally heard in both channels of stereo phones.

Note:

 DSE effect cannot be heard in mono phones and internal MB1 dynamic.

NR and **ANF** parameters:

- **Taps** - filter taps, determines the quality of the filter functionality.
- **Delay** - trigger delay time.
- **Rate** - set the adaptation rate of the filter.
- **Leak** - set the signal's level.

Noise blanker parameters:

- **Threshold NB 1** - filter 1 trigger threshold.
Set the required filter 1 trigger threshold, depends on the interference level.
- **Threshold NB 2** - filter 2 trigger threshold.
Set the required filter 2 trigger threshold, depends on the interference level.

APF - Analog Peak-Filter for CW mode.

- **Gain** - Analog peak-filter amplifying factor.
Set the required gain of the analog peak-filter.

- **Quality** - Analog peak-filter quality.
Set the required quality of the analog peak-filter.

DSE - Digital Surround Effect for CW signals.

- **Quality** - DSE filter quality.
Set the required quality of the DSE filter. The higher the quality value the more prominent function's effect.
- **Swap channels** - Swap right and left receiver's channels.
Set the **Swap channels** checkbox for correct DSE functionality, if required. Correct functionality - slowly increasing the receiver tuning frequency, while receiving the CW signal, sounds as if CW signal moves from the right to the left channel.

Filter taps - receiver's filter taps.

The higher the receiver's filter taps value, the more rectangle filter shape, but also longer signal pass delays. That is why user should find the best settings for himself, between acceptable filter shape steepness and signal delay. Optimal filter taps are set by default.

Default - press to return settings to the default state. Each settings category has **Default** button.

Press the **Default** button if you set wrong values and don't like the result.

5.3.1.6 TX

On the **TX** tab you can see the transceiver's settings.

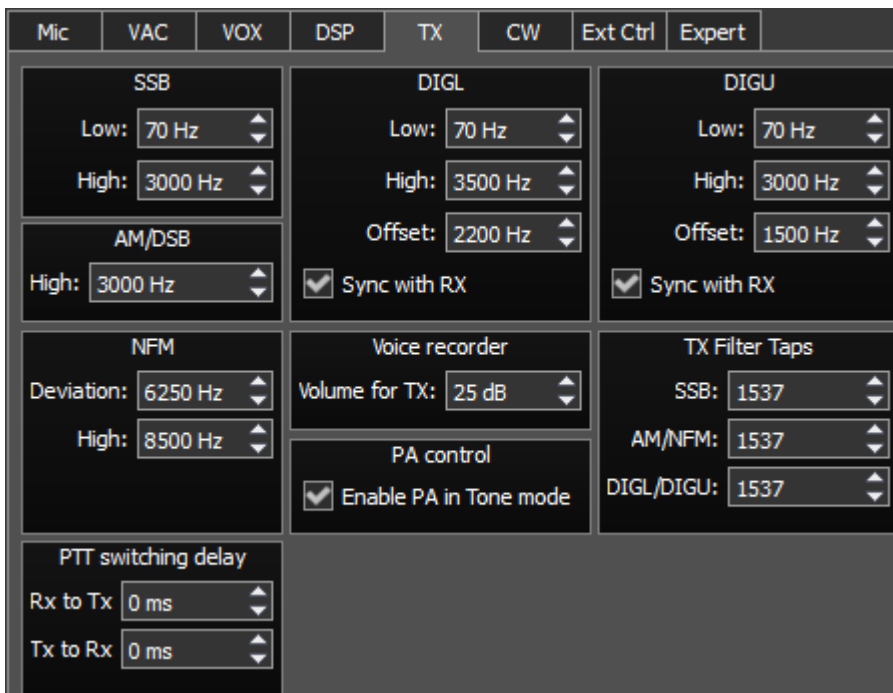

SSB/DIGL/DIGU/AM/DSB - settings for the low or/and high TX filter fronts.

- **Low** - low front filter's frequency.

- **High** - high front filter's frequency.
- **Offset** - frequency offset.
Used for work in digital modes. Frequency offset requirement depends on the used digital mode program. Look at the instruction of your digital mode program.
- **Sync with RX** - Галка

NFM - Narrow band receiver FM settings.

- **Deviation** - FM deviation.
Width of the FM signal in air will be two times more than deviation.
- **High** - Frequency of the high filter slope of the LF signal before FM demodulator.
Set the required LF signal width from zero up to high filter edge.

Voice Recorder - Settings of the internal dynamic's playback level.

- **Volume for TX** - internal dynamic's volume.
Set this parameter so that the signal on MIC-meter would reach -10...-5 dBW values (more details in [Voice Recorder Operation](#)¹⁷⁶).

TX Filter Taps - Transmit Filter Taps settings.

- **SSB** - Filter Taps in SSB mode.
- **AM/NFM** - Filter Taps in AM mode and narrowband FM.
- **DIGL/DIGU** - Filter Taps in DIGL and DIGU modes.

PA control - External PA control settings.

- **Enable PA in Tone mode** - Checkbox to enable the TX mode of the external PA in the Tone mode (transmission of the carrier frequency).
Set the **Enable PA in Tone mode** checkbox to enable the TX mode for the external PA while transmitting the carrier frequency. This mode might be useful to tune the building-out network of the external PA.

High SWR protection - Trigger threshold of the transceiver's high SWR protection in the TX mode.

- **SWR \geq :** - Protection trigger threshold by SWR.

Warning!

- ① **Increasing the protection trigger threshold by SWR more than 4, may lead to transceiver failure!**
-

5.3.1.7 CW

On the **CW** tab you can see the settings of the secondary CW keys.

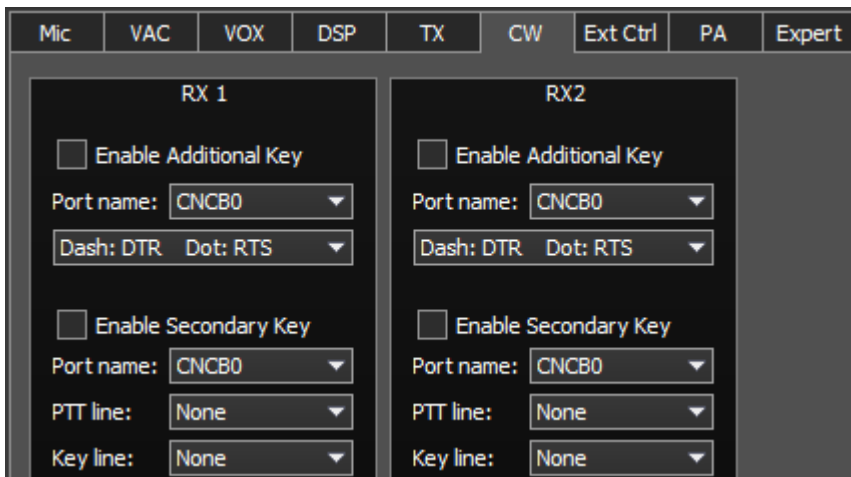

RX1, RX2 - These categories have similar settings for RX1 and RX2 receivers.

- **Enable Additional Key** - Checkbox to enable additional CW keys.
Set the **Enable Additional Key** checkbox to enable additional iambic CW key, which is connected to the COM-port.
- **Port name** - COM-port number, which is connected to the key.
- **Lines** - Lines menu, used for Dot and Dash signals.
In the **Lines** menu you may swap Dot and Dash signals with COM-port bits RTS and DTR.
- **Enable Secondary Key** - Checkbox to enable secondary additional CW key.
Set the **Enable Secondary Key** checkbox to enable secondary additional CW key, which is connected to the COM-port. As a rule this port is being used for CW signal generated by the additional software (message logs, contest logs and others).
- **Port name** - COM-port number, which is connected to the key.
- **PTT line** - Line menu, is being used to turn the transceiver to the TX mode.
- **Key line** - Line menu, is being used to generate CW signal.

5.3.1.8 Ext Ctrl

On the **Ext Ctrl** tab you can see the settings of the electronic keys.

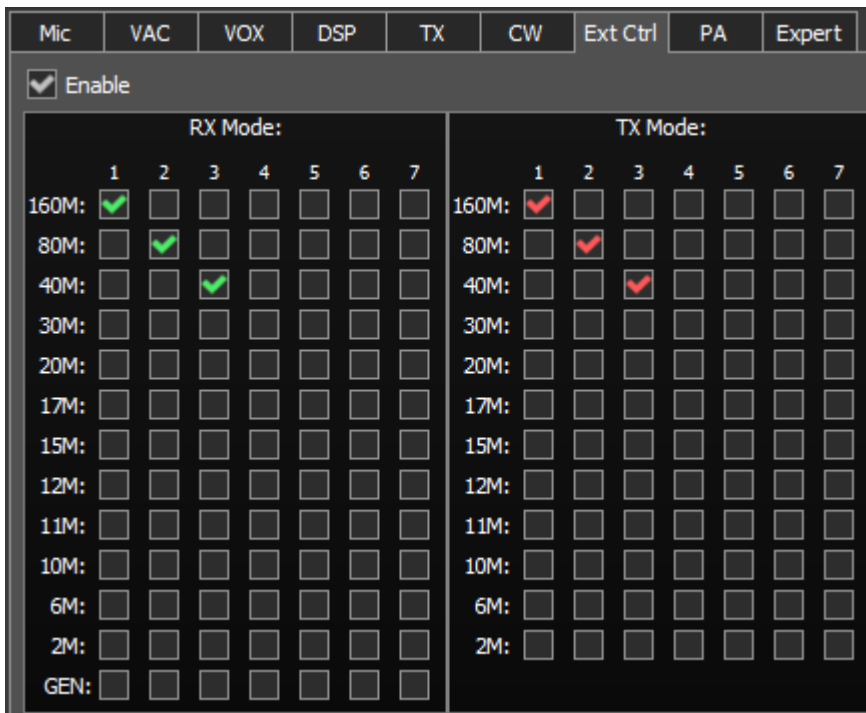

Enable - Checkbox to enable control of the electronic keys.

Set the **Enable** checkbox to work with keys.

Rx Mode - Electronic keys settings in the RX mode.

- **1...7** - Electronic keys numbers.
- **160...2, GEN** - Electronic key enable checkbox on the corresponding band.

TX Mode - Electronic keys settings in the TX mode.

- **1...7** - Electronic keys numbers.
- **160...2** - Electronic key enable checkbox on the corresponding band.

Note:

☎ On the picture you can see an example of using the keys in the 160M, 80M and 40M bands for both RX and TX modes.

While working on the 160M band in the RX mode, #1 key is enabled, if turn to TX mode, #1 key is still active.

While turning on 80M band, #2 key will be enabled (#1 key will be disabled), it is active in both RX and TX modes.

While turning on 40M band, #3 key will be enabled (#2 key will be disabled), it is active in both RX and TX modes.

Connect the relays to these keys, you may create an additional antenna switch, band filters switch, PA band switch etc.

5.3.1.9 PA

On the **PA** tab you can see the settings of the electronic PTT keys - which control the TX mode of the external power amplifiers (PA).

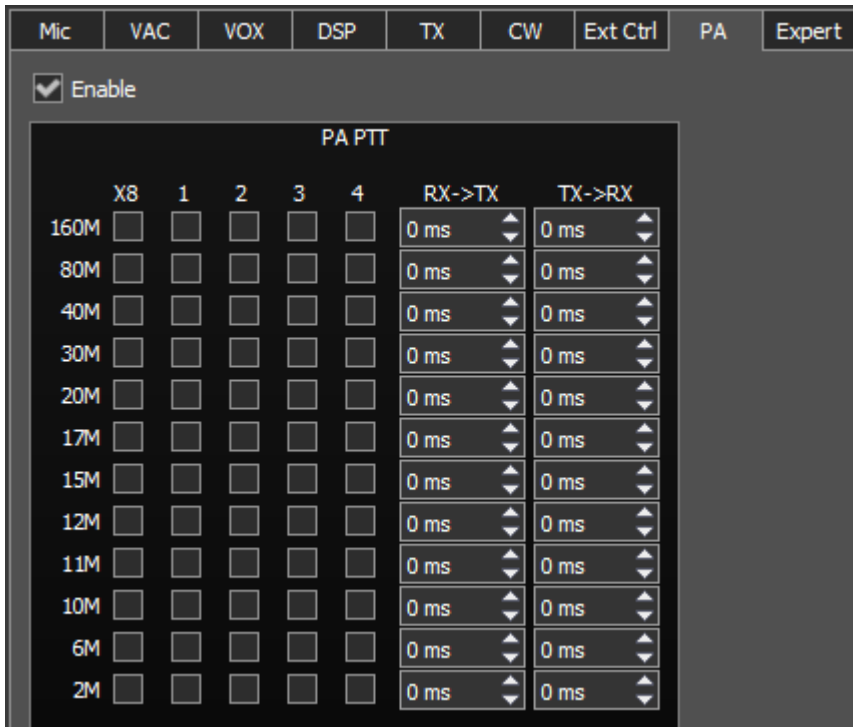

Enable - Checkbox to enable control of the electronic keys. Set the **Enable** checkbox to work with keys.

PA PTT - PTT keys settings.

- **X8** - Control PTT key of the external PA. Key's output placed on the rear panel of the transceiver in the EXT CTRL connection. (more details in [EXT CTRL](#)²⁹).
- **1...4** - Control PTT keys of the external PAs. Keys' outputs placed on the rear panel of the transceiver on the corresponding connections PTT 1-4 (more details in [PA PTT outputs](#)³⁰).
- **RX->TX** - HF signal delay, after RX->TX turn.
- **TX->RX** - TX->RX turn delay after the PTT signal disabled.
- **160M-2M** - Electronic keys enable checkboxes on the corresponding bands. Choose the electronic keys, which will be enabled on the corresponding bands. One key could be assigned to several bands. e.g. if you use the wide band PA for 160M-10M bands and control it with #1 key, then you should set the checkboxes for corresponding bands.

5.3.1.10 Expert

On the **Expert** tab you can see the fine hardware settings of the transceiver.

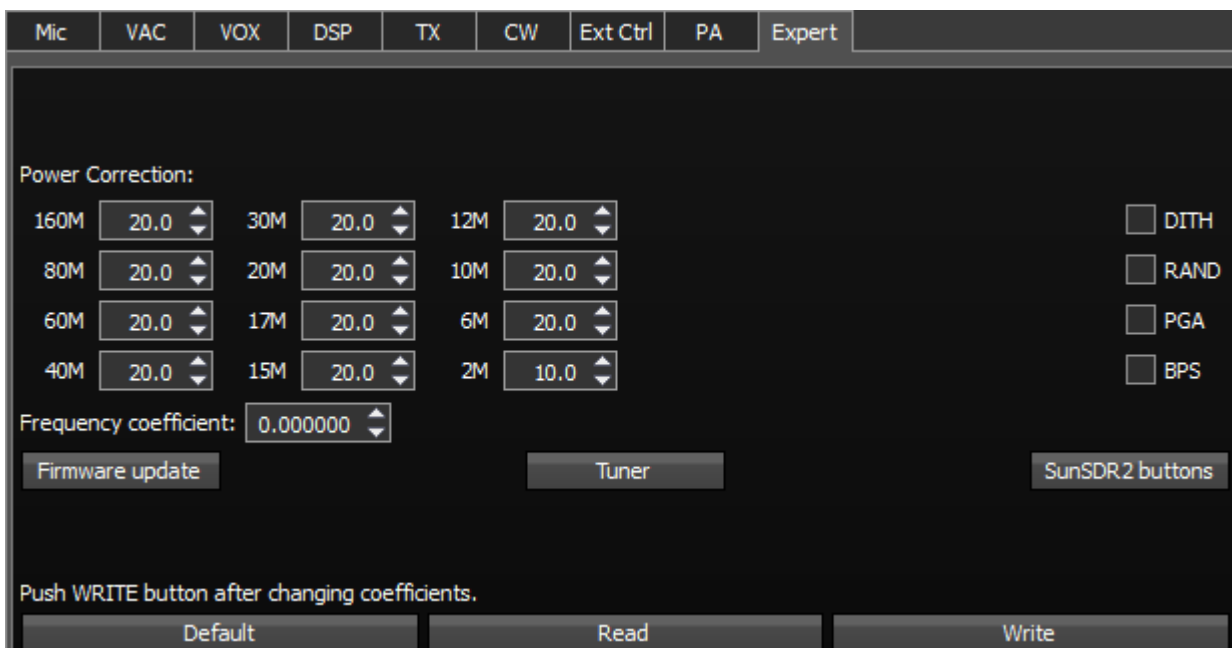

Note:

- ☎ All settings in this tab are stored in the transceiver's energy independent memory.
- ☎ After setting the required values, set/unset checkboxes, press the **Write** button to store the info in the memory.
- ☎ To read the current settings state from the memory, press the **Read** button. Auto-read happens with every software launch.

Power Correction - Output power correction menu of the transceiver by bands.

Set the output power value for each band. Value = 20 means maximum output power of the transceiver.

Note:

- ☎ After tuning the power values, press the **Write** button.

Frequency coefficient - Correction menu of the transceiver's frequency tuning.

Set the coefficient that the transceiver's tuning frequency would be equal to the real frequency of the received signal.

Note:

☎ Correction of the displayed frequency could be made according to the time signals on the 4.996MHz, 9.996MHz or 14.996MHz (preferably) frequencies, where you can find easily tracked pulse signals. If they do not match with the tuned frequency, adjust the **Frequency coefficient** till the frequency match.

☎ The higher the frequency of the used time signal, the higher calibration accuracy.

☎ Calibration should be performed with the maximum panorama zoom and maximum FFT size of the panorama (more detail about FFT size in [Spectrum](#) ^{□85}).

☎ After you set the frequency correction coefficient, press the Write button.

☎ The devices are calibrated at the manufacturing by default, additional calibration is not required.

Firmware update - Button for manual firmware update in the transceiver's SDR module.

Press the **Firmware update** button to initialize firmware update process.

Tuner - Button for manual firmware update in the transceiver's ATU module.

Press the **Tuner** button to initialize firmware update process.

MB1 buttons - Input lines control button.

Press the **MB1 buttons** button to open the text window for lines control of CW key, PTT footswitch and PTT microphone button.

DITH - Checkbox to enable the internal noise source in the ADC.

Set the **DITH** checkbox to enable internal noise source of the receiver's high-speed ADC.

Note:

☎ After set/unset of the **DITH** checkbox, press the **Write** button .

☎ Internal noise source in the ADC gives an additional linearity to the receiver's ADC functionality. As a rule used for lab measurements for receiver's linearity with other devices.

☎ While operating in real air, noise source is an actual noise of the air, that's why there is no need to enable **DITH** function.

☎ If **DITH** is enabled, receiver's own noise is increased.

RAND - Checkbox to enable bits randomizing on the ADC's data bus.
 Set the **RAND** checkbox to enable bits randomizing on the receiver's ADC data bus.

Note:

 After set/unset of the **RAND** checkbox, press the **Write** button.

 Bits randomizing on the ADC's data bus leads to lessening the noise from this bus to the receiver.

 It is recommended to keep this checkbox on all the time.

Default - Default hardware settings button.
 Press the **Default** button to return to the default settings.

Read - Read the hardware settings from the transceiver's memory.
 Press the **Read** button to read the hardware settings from the transceiver's memory.

Write - Store the hardware settings.
 Press the **Write** button to store the hardware settings in the transceiver's memory.

5.3.2 Sound card menu

In the **Sound card** menu you can see the settings of the audio devices, which can be used with the transceiver.

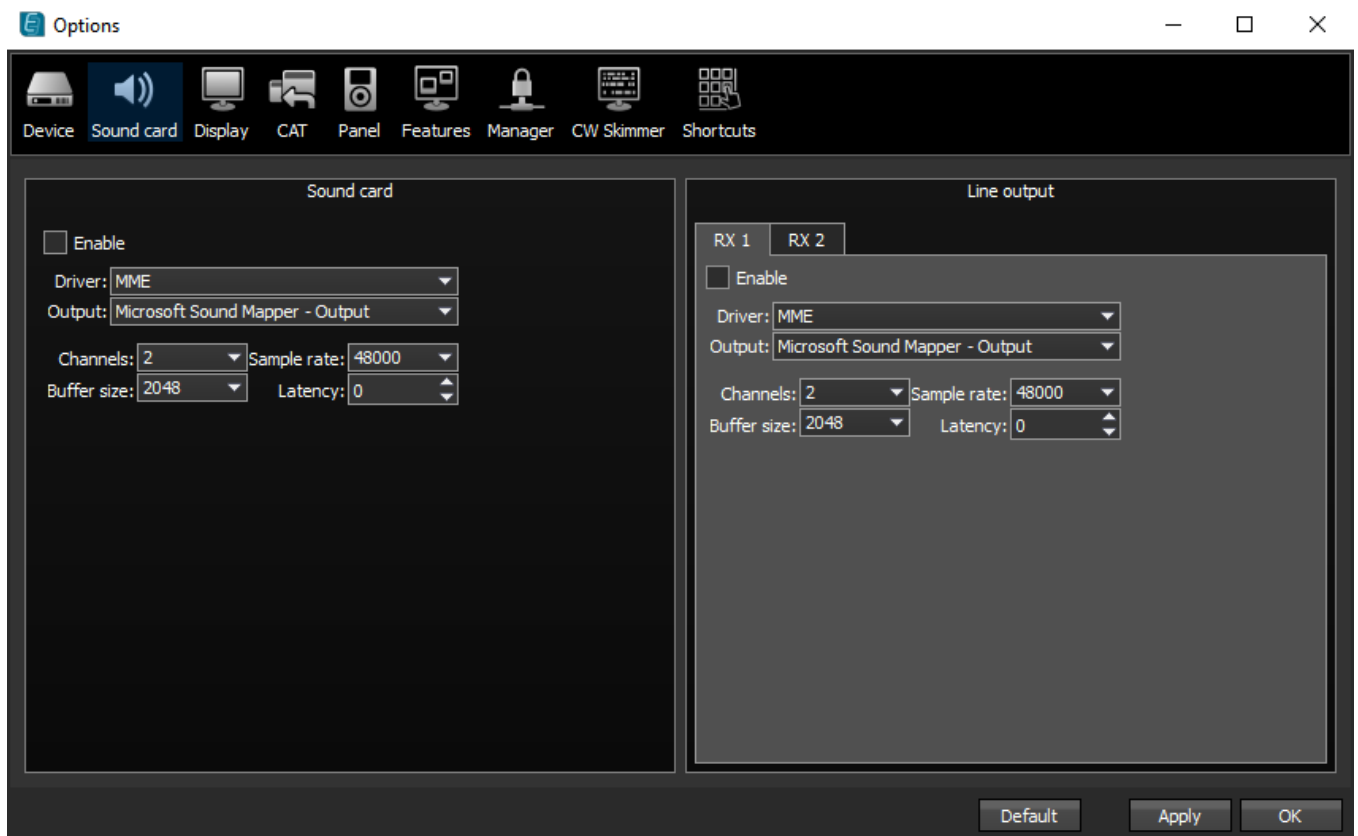



5.3.2.1 Sound card

In the **Sound card** category you can see the settings of the sound card, which can be used for sound output in the RX mode.

Note:

 Sound output via the **Sound card** will be simultaneous with the sound from the transceiver via the sound codec, placed in the SDR module.

 **Sound card** volume is adjusted by rotating the AF knob on the front panel of the transceiver.

 Delay for the signal output via the sound card could reach 30-500 ms.

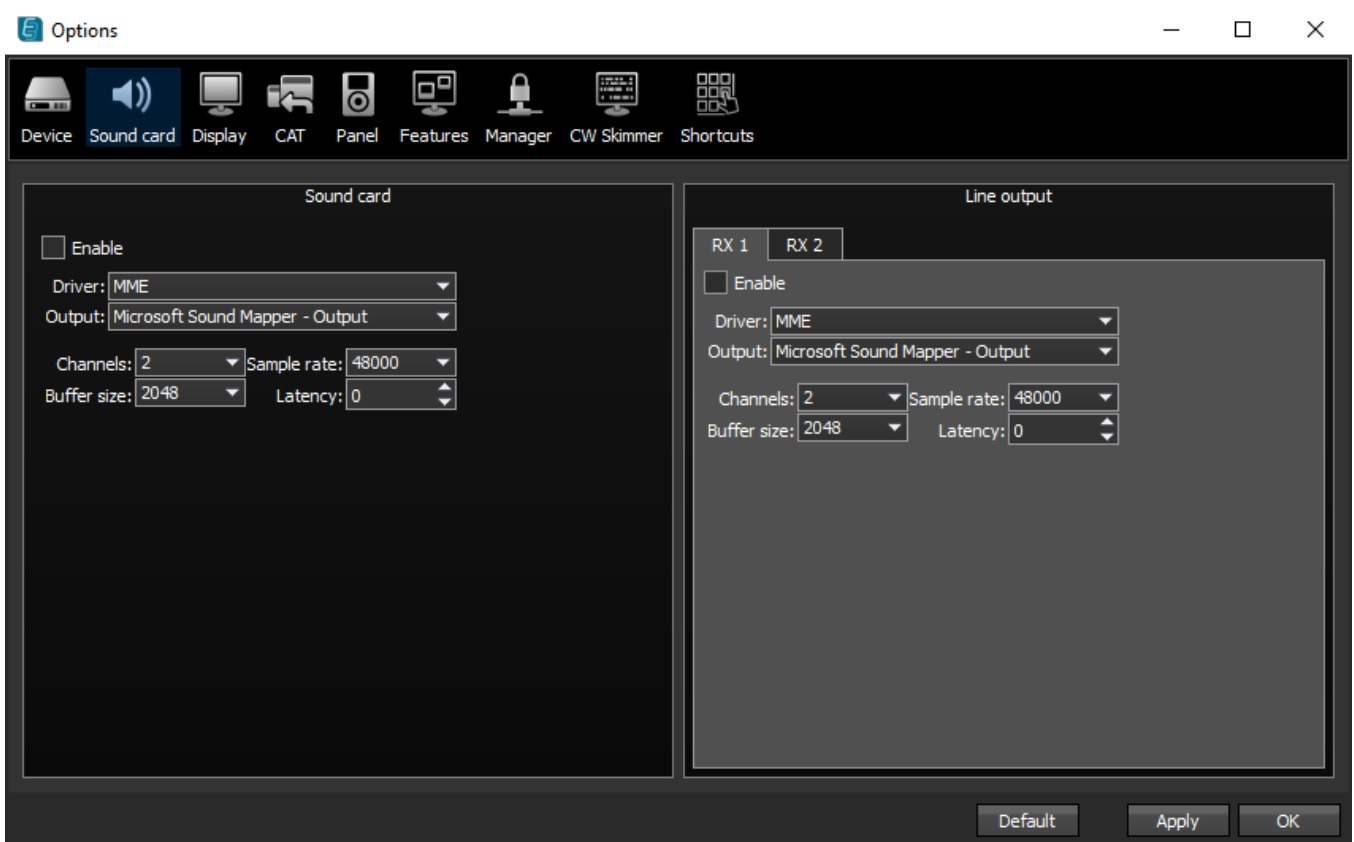

- **Enable** - Checkbox to enable PC's sound card.
Set the **Enable** checkbox to enable sound output via the sound card.
- **Driver** - Choose the sound card's driver type.
- **Output** - Choose the sound card's physical output.
- **Channels** - Choose the amount of active sound card's channels.
- **Sample rate** - Sampling frequency.
- **Buffer size** - Buffer size.
- **Latency** - signal delay time.

Note:

 Before you'll enable the **Sound card** by the **Enable** checkbox, make sure that all sound devices settings are set correctly.

5.3.2.2 Line output

In the **Line output** category you can see the settings of the sound card or virtual audio cables, which could be used for linear sound output in the RX and TX modes, separately for RX1 and RX2 receivers.

Note:

☎ Sound output via the **Line output** will be simultaneous with the sound from the transceiver.

☎ **Line output** volume has a constant max value and can not be changed by the operator.

☎ As a rule sound output via the **Line output** is used for recording communications on contests and other purposes.

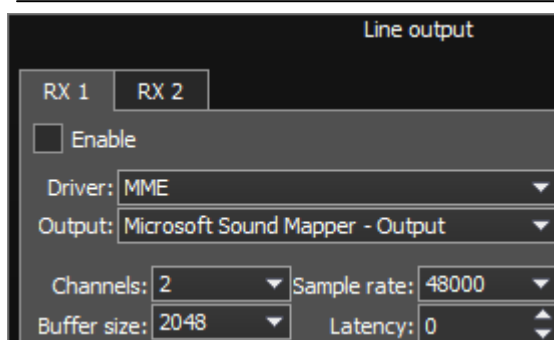

There are two two tabs with identical settings for RX1 and RX2 receivers, in the **Line output** category, let's look at one of them.

- **Enable** - Checkbox to enable **Line output**.
Set the **Enable** checkbox to enable **Line output**.
- **Driver** - Choose the sound device' driver type.
- **Output** - Choose the sound device' physical output.
- **Channels** - Choose the amount of active sound device' channels.
- **Sample rate** - Sampling frequency.
- **Buffer size** - Buffer size.
- **Latency** - signal delay time.

Note:

☎ Before you'll enable the **Line output** by the **Enable** checkbox, make sure that all sound devices settings are set correctly

☎ You can use the sound card as a sound device - the signal goes out of the transceiver, you can use the virtual audio cable as a sound device - the signal goes in the transceiver in the software, which functions on the internal PC, e.g. in contest log.

5.3.3 Display menu

In the **Display** menu you can see the settings of the transceiver's software display. Display settings in the **Device** menu are placed according to their purposes:

- «**Main window**» tab
- «**Spectrum**» tab
- «**Waterfall**» tab
- «**Grid**» tab
- «**Filter**» tab
- «**Background**» tab

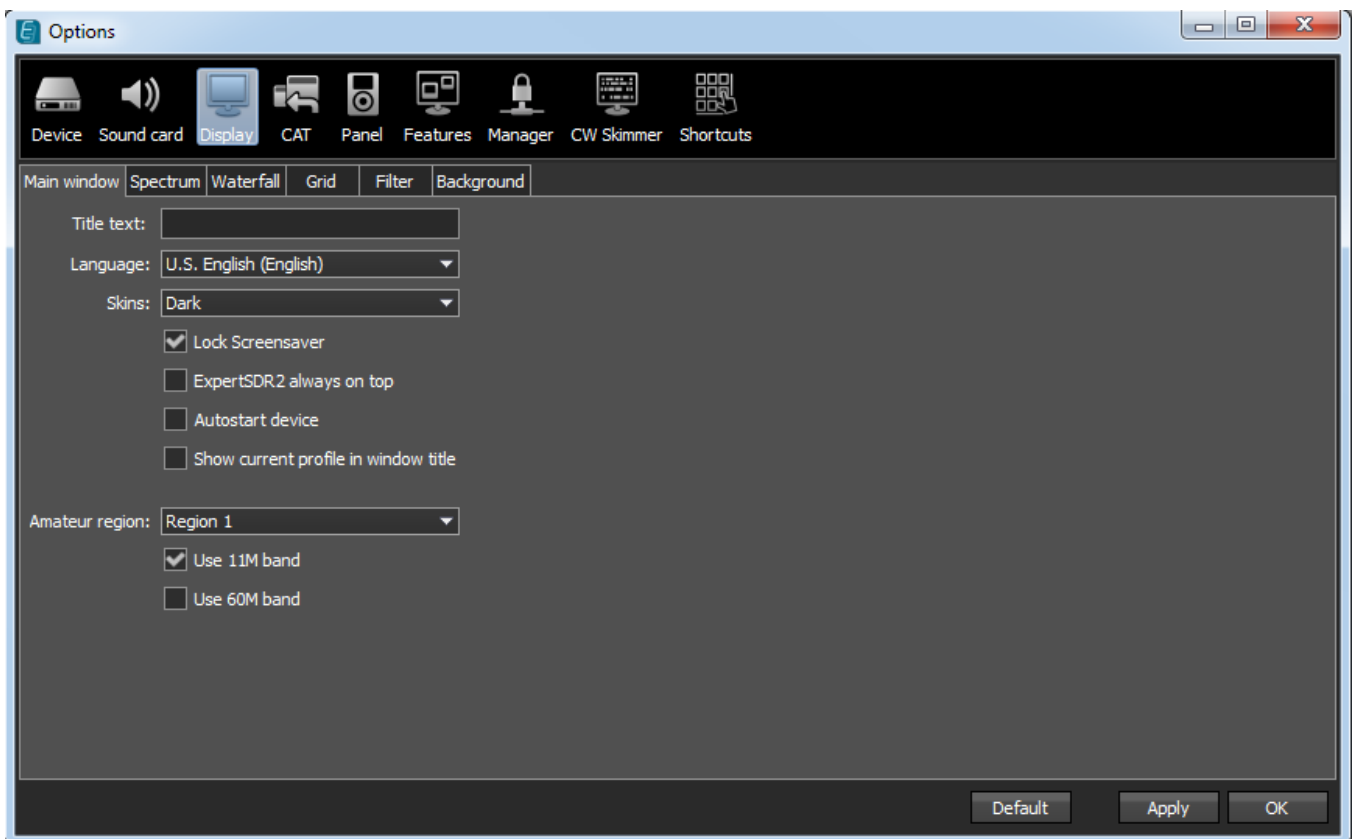

5.3.3.1 Main window

On the **Main window** tab you can see the settings of the transceiver's software main window display.

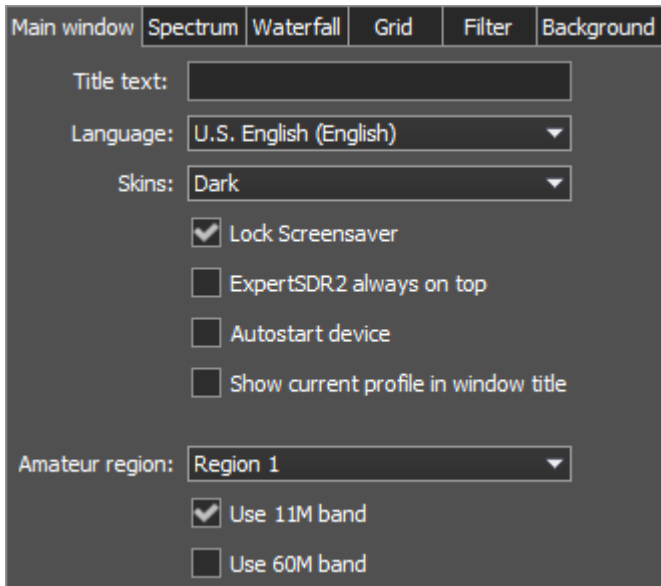

- **Title text** - Input box to enter the title.
Enter in the **Title text** box - your call-sign or other information, it will always be displayed in the software title.
- **Language** - Interface language menu.
Choose the required language from the list.
- **Skins** - Software color theme menu.
Choose the required software color theme from the list.
- **Lock Screensaver** - Lock screensaver checkbox.
Set the **Lock Screensaver** checkbox to block the display turn off by the Windows OS.
Recommended checkbox setting - on.
- **ExpertSDR2 stays on top** - On top checkbox.
Set the **ExpertSDR2 stays on top** checkbox to see ExpertSDR2 window constantly on top of other windows.
Recommended checkbox setting - off.
- **Autostart device** - Receiver's autostart checkbox.
Set the **Autostart device** checkbox to automatically start the receiver after the launch of the software.
Recommended checkbox setting - on.
- **Show current profile in window title** - Display the current profile in the software window title.
Set the **Show current profile in window title** checkbox to display the current profile (if the profile is on) in the software window title.

- **Amateur region** - Amateur region menu.

Choose the region you are currently in, in the Amateur region menu.

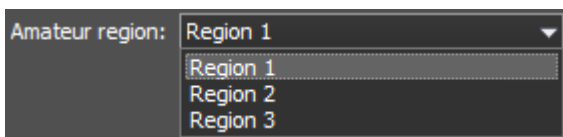

It affects the position of the amateur bands in the software.

- **Use 11M band** - 11M band enable checkbox.
Set the **Use 11M band** checkbox to enable 11M band.
- **Use 60M band** - 60M band enable checkbox.
Set the **Use 60M band** checkbox to enable 60M band.

Note:

☎ After you choose the amateur region and/or set the checkbox **Use 11M/60M band** you'll see the notification window, that the settings will be applied after the restart of the software. Restart the software.

5.3.3.2 Spectrum

On the **Spectrum** tab you can see the transceiver's spectrum settings.

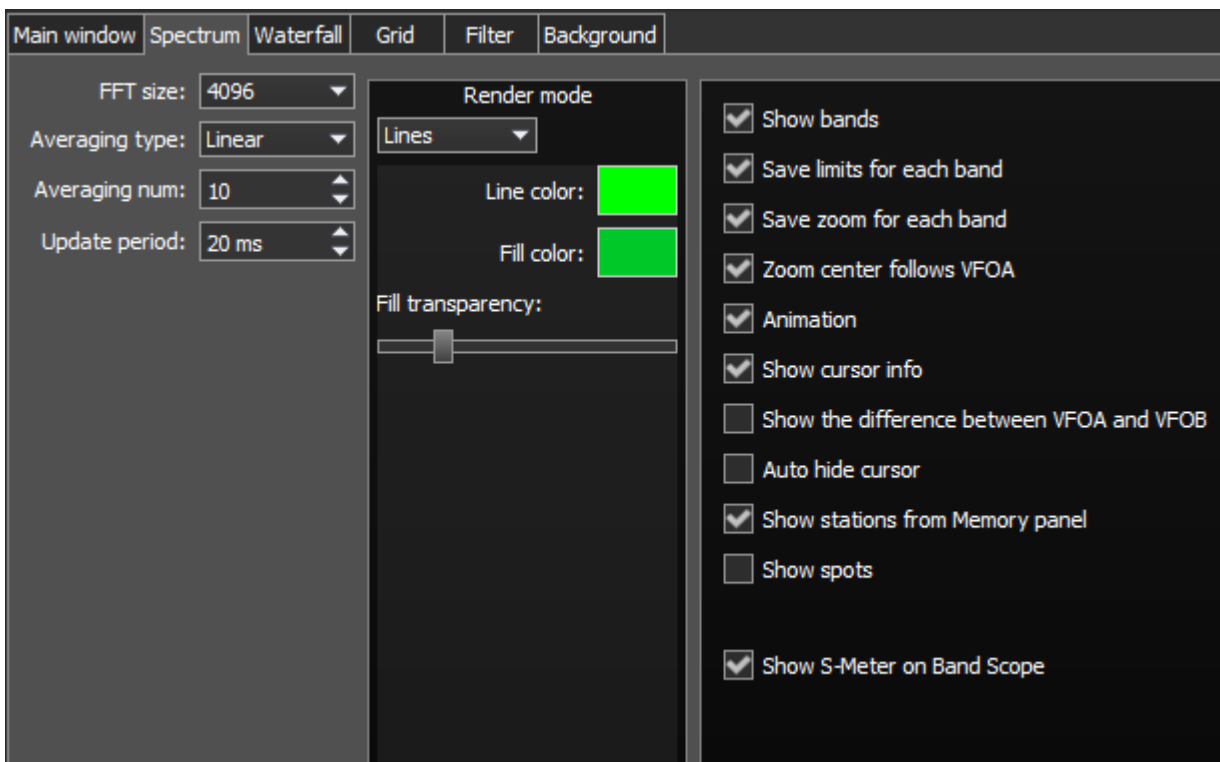

- **FFT size** - Fast Fourier Transform (FFT) size of the spectrum scope.
Choose the required FFT size. The higher FFT size, the higher spectrum scope resolution by frequency, along with the higher processor load.

- **Averaging type** - Spectrum scope averaging type menu.
Choose the averaging type from the list: Linear, root-mean-square (Rms), Exponential, which suits you best.
- **Averaging num** - Amount of samples for averaging.
Set the required amount of samples for averaging. The bigger the amount of samples, the slower the specter will change on the graph.
- **Update period** - Spectrum scope update period.
Set the required specter's graph update period. The bigger the number, the more FPS on the spectrum scope, along with the higher processor load.
- **Render mode** - Specter render mode: lines, gradient.
Set the required specter render mode.
- **Line color** - Spectrum scope line color.
Choose the required line color from the palette.
- **Fill color** - Fill color of the spectrum scope lower area.
Choose the required fill color from the palette.
- **Fill transparency** - Transparency slider for the spectrum scope lower area filling.
Set the required filling transparency level.
- **Show bands** - Show amateur bands borders.
Set the **Show bands** checkbox to show amateur bands borders at the top of the spectrum scope (blue line).
- **Save limits for each band** - Save spectrum scope amplitude limits for each band.
Set the **Save limits for each band** checkbox to enable the software to save set spectrum scope limits for each band.
- **Save zoom for each band** - Save spectrum scope zoom settings for each band.
Set the **Save zoom for each band** checkbox to enable the software to save spectrum scope zoom settings for each band.
- **Zoom center follows VFOA** - Zoom center marker locked on the VFOA position on the spectrum scope.
Set the **Zoom center follows VFOA** checkbox to enable zoom center marker lock on the VFOA position.
- **Animation** - Spectrum scope animation while transition between bands.
Set the **Animation** checkbox to enable animation.
- **Show cursor info** - Show frequency and dB level of the cursor position.
Set the **Show cursor info** checkbox to enable info display near the cursor on the spectrum scope.

- **Show the difference between VFOA and VFOB** - Show the difference between VFOA and VFOB.
Set the **Show the difference between VFOA and VFOB** checkbox to display the difference between VFOA and VFOB near the cursor.
- **Auto hide cursor** - Automatically hide the cursor from the spectrum scope.
Set the **Auto hide cursor** checkbox to let the cursor disappear after idle 2 seconds.
- **Show stations from Memory panel** - Show the stations previously stored in the frequency memory.
Set the **Show stations from Memory panel** checkbox to show on the spectrum scope previously stored stations as a markers (blue dots in the top area of the spectrum scope).
When rollover the station's marker you'll see the commentary.
- **Show spots** - Show spots from the CW Skimmer on the spectrum scope.
Set the **Show spots** checkbox to show spots from the CW Skimmer on the spectrum scope as a markers with call-signs.
- **Show S-Meter on Band Scope** - Show the S-Meter on the Band Scope.
Set the **Show S-Meter on Band Scope** checkbox to show the S-Meter on the Band Scope for each VFO.

5.3.3.3 Waterfall

On the **Waterfall** tab you can see the transceiver's waterfall settings.

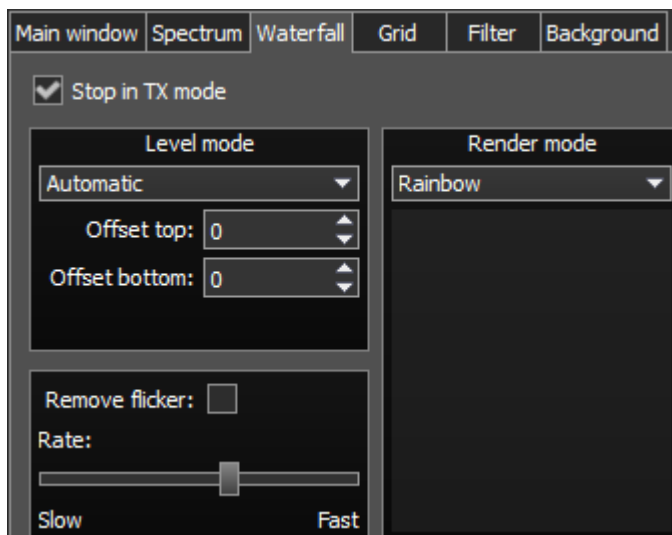

- **Stop in TX mode** - Stop the waterfall in TX mode.
Set the **Stop in TX mode** checkbox to disable the waterfall while transmitting.
- **Level mode** - Waterfall bright menu.
Choose the bright mode from the list: Automatic, Synchronous.
Synchronous mode depends on the set limits of the spectrum amplitude.
Automatic mode depends on air signals and set offset in the settings below.

- **Offset top** - Offset input box by the top dB level relatively to signals level.
Set the offset in the **Offset top** box to determine the maximum brightness relatively to the max signals' levels.
- **Offset bottom** - Offset input box by the bottom dB level relatively to signals level.
Set the offset in the **Offset bottom** box to determine the minimum brightness relatively to the min signals' levels.
- **Render mode** - Waterfall render mode menu: Rainbow, Monochrome, Custom.
Choose the required color render of the waterfall, depending on your choice or tasks.
- **Remove flicker** - Checkbox to remove the waterfall flickers.
Set the **Remove flicker** checkbox to get rid of the texture flickers in the waterfall. Also it slightly clears the waterfall from air noises.
- **Rate** - Waterfall movement speed slider.
Set the **Rate** slider according to the required waterfall movement speed.

5.3.3.4 Grid

On the **Grid** tab you can see the spectrum scope grid display settings.

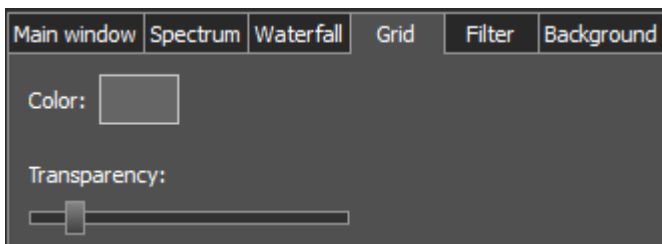

- **Color** - Color of the the spectrum scope grid.
Choose the required grid color from the palette.
- **Transparency** - Grid transparency slider.
Set the required grid transparency by moving the slider.

5.3.3.5 Filter

On the **Filter** tab you can see the filter's display settings on the spectrum scope and waterfall.

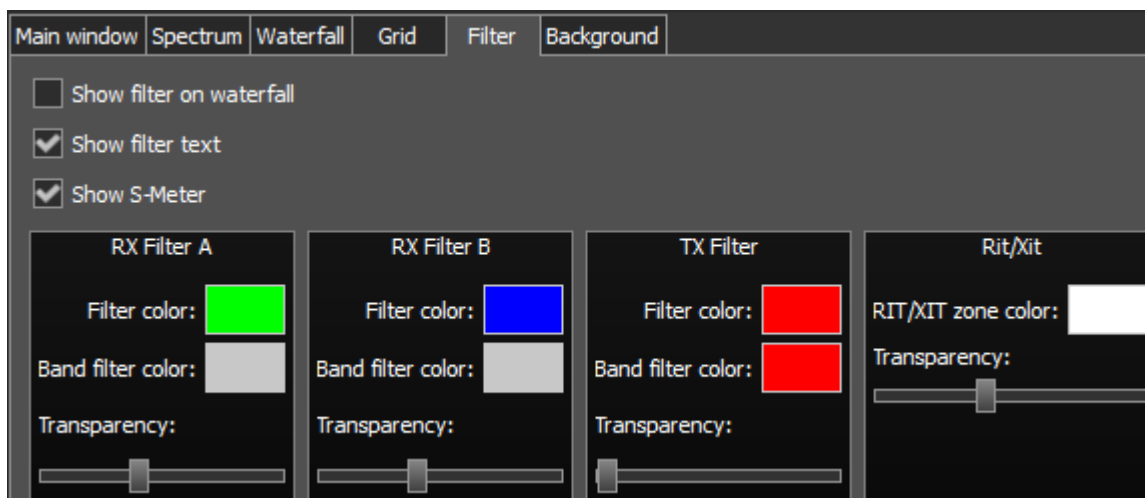

- **Show filter on waterfall** - Show receiver(s) filter on the waterfall.
Set the **Show filter on waterfall** checkbox to show receiver(s) filter on the waterfall.
- **Show filter text** - Show text info near the receiver's filter on the spectrum.
Set the **Show filter text** checkbox to display filter's tuned frequency, signal level in S-units etc. in the used filter bandwidth.
- **Show S-Meter** - Enable animated S-Meter near the receivers' filter on the spectrum.
Set the **Show S-Meter checkbox** to display S-Meter near the receiver's filter.

In the **RX Filter A**, **RX Filter B**, **TX Filter** categories displayed filters' color and transparency settings.

- **Filter color** - Filter's frequency color menu.
Choose the required filter's tuned frequency color from the palette.
- **Band filter color** - Filter's bandwidth color menu.
Choose the required filter's bandwidth color from the palette.
- **Transparency** - Filter's transparency slider.
Set the required filter's transparency.

In the **Rit/Xit** category displayed RIX/XIT active zone settings.

- **Rit/Xit zone color** - RIX/XIT active zone color menu.
Choose the required RIX/XIT active zone color from the palette.
- **Transparency** - RIX/XIT zone transparency slider.
Set the required RIX/XIT zone transparency.

5.3.3.6 Background

On the **Background** tab you can see the spectrum scope background settings.

Background type - Spectrum scope background type menu: **Solid**, **Gradient**, **Image**.

Choose in the **Background type** menu spectrum scope background render type.

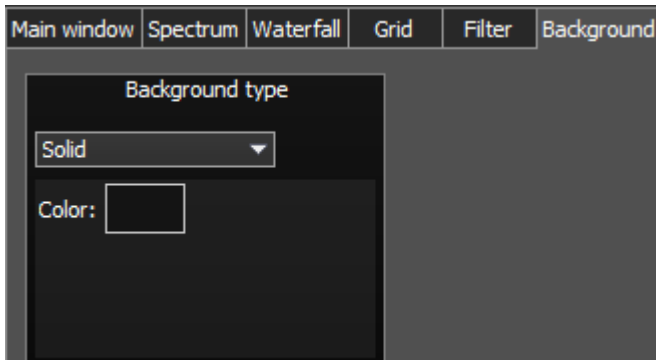

In the **Solid** mode available settings are:

- **Color** - Background color menu.
Choose the required background color from the palette.

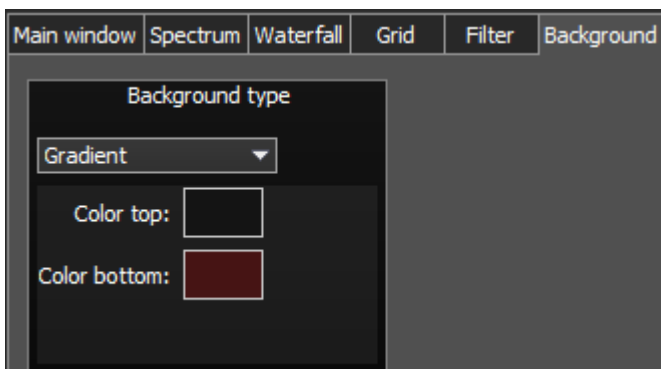

In the **Gradient** menu available settings are:

- **Color top** - Top gradient color of the background.
Choose the required top gradient color from the palette.
- **Color bottom** - Bottom gradient color of the background.
Choose the required bottom gradient color from the palette.

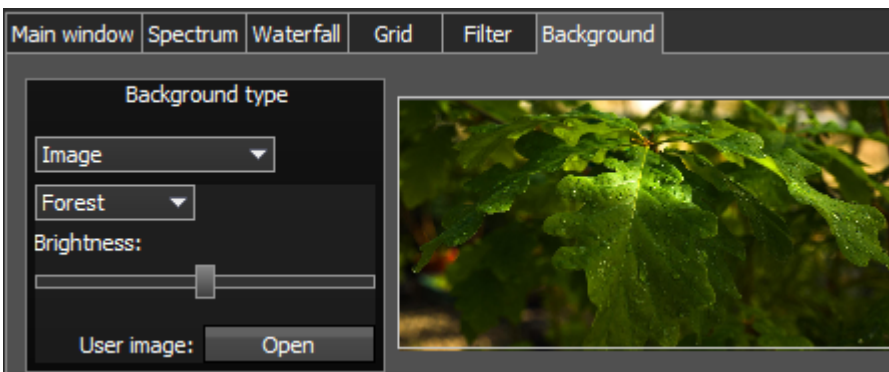

In the **Image** menu available settings are:

- **Image menu** - Image presets menu (Forrest, Bubbles, Space, Water, User). Pick the required image from the menu or lock one of your own images.
- **Brightness** - Background image brightness slider. Set the required background image brightness.
- **User image** - Choose the required image to be displayed on the background. Press the **Open** button, in the opened window choose the image file to set as the background.

Note:

 If the image file wasn't chosen previously via the **Open** button, then if you choose the User image in the presets list it'll open the window to choose the image file.

 Supported files types: png, jpg, jpeg, bmp.

5.3.4 CAT menu

In the **CAT** menu you can see the settings CAT-system. CAT-system is the transceiver's exchange interface with an external devices and software.

CAT-interface is used to control the transceiver from a third-party software. This could be contest logs, digital modes decoder-software, SAT-tracker etc.

Software receivers 1 and 2 could be controlled separately via the CAT-protocol.

Protocol - Exchange protocol with an external devices or software.

Choose the required exchange protocol from the list.

- **TS-480** - Exchange protocol compatible with TS-480 transceiver. Choose this protocol to exchange data with an external devices and software via COM-port. When you choose this protocol, will be available separate settings for RX1 and RX2 on corresponding tabs.
- **OmniRig** - Exchange protocol via the OmniRig software. Choose this protocol to exchange data with an external devices and software via OmniRig software.

Note:

 Via the OmniRig software could be send a limited amount of control commands.

Available control commands:

- Set VFO frequency, if no VFOB in the CAT protocol;
- Set VFO A frequency;
- Set VFO B frequency;
- Enable receiver's RIT offset;
- Set RIT offset;
- Reset RIT offset;
- Enable transceiver's XIT offset;
- Set mode type;
- Enable SPLIT.

5.3.4.1 RX1 receiver

RX1 tab contains a CAT-system settings and control of the transceiver's PTT command via COM-ports for the RX1 receiver.

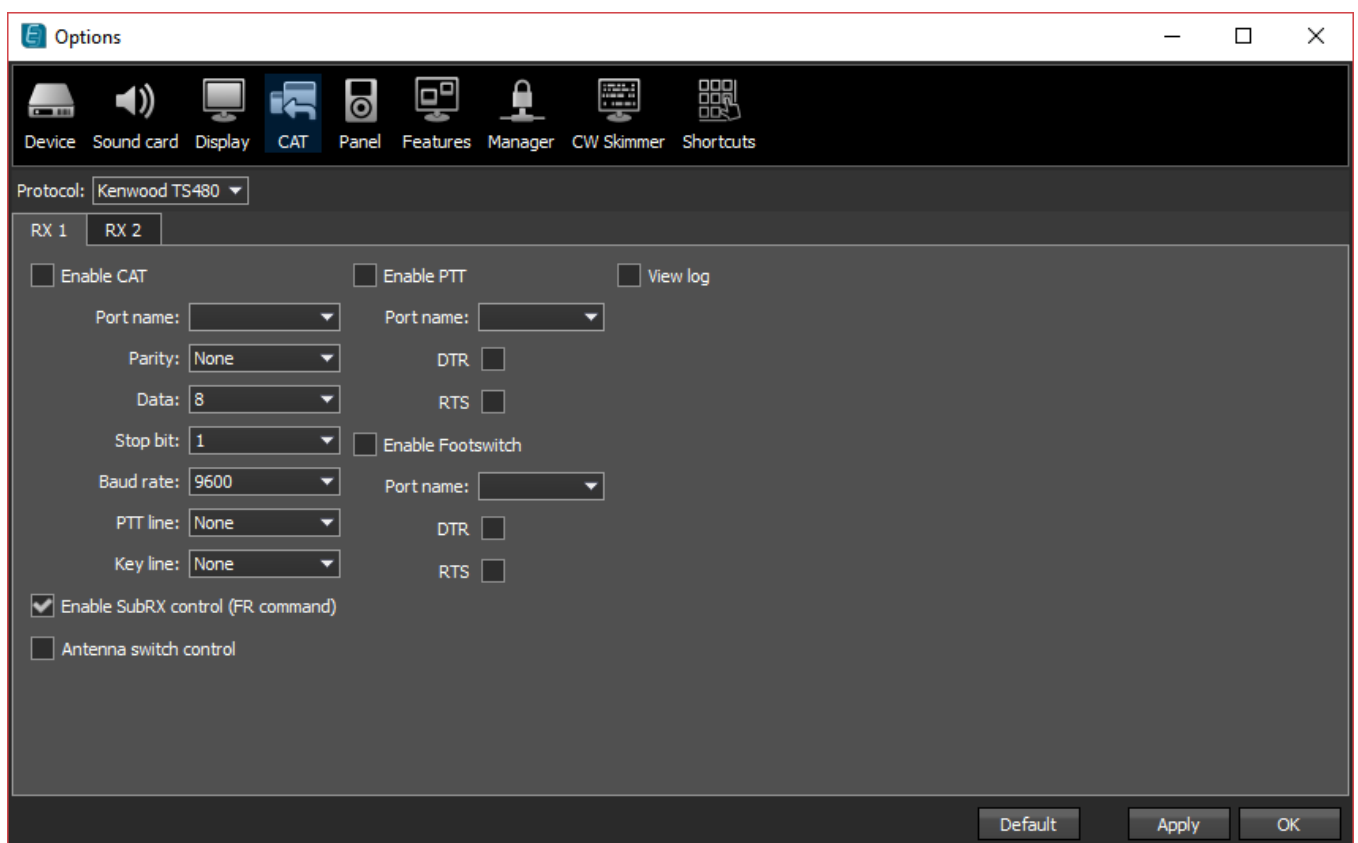

- **Protocol** - Exchange protocol menu with external devices.
Select the required exchange protocol with external devices or software from the list.

- **Enable CAT** - Checkbox to enable control of the transceiver via the CAT-system.
- **Port name** - COM-port number.
- **Parity** - Parity.
- **Data** - Amount of data in bits.
- **Stop bit** - Amount of stop bits.
- **Baud rate** - Port speed.
- **PTT line** - COM-port line to activate the TX mode.
- **Key line** - COM-port line for the CW mode.
- **DTR/RTS** - COM-port line for the PTT mode.

- **Enable SubRX control (FR command)** - Checkbox to enable control of the sub-receiver via the CAT-system.
Set the **Enable SubRX control (FR command)** checkbox to enable the control of the sub-receiver via the CAT-system.

- **Antenna switch control** - Checkbox to enable control of the antenna switch via the CAT-system.
Set the **Antenna switch control** checkbox to enable the control of the antenna switch via the CAT-system. Useful for the Ham Radio Deluxe software.

- **Enable PTT** - Checkbox to enable control of the TX mode via the COM-port.
Set the **Enable PTT** checkbox to enable the control of the TX mode via the COM-port.
- **Port name** - COM-port number.
- **DTR/RTS** - COM-port line for receiving the PTT commands.
Set one of the **DTR/RTS line** checkbox to select them as control.

- **Enable Switch** - Checkbox to enable control of rerouting the PTT signal from footswitch to additional COM-port.
Set the **Enable PTT** checkbox to enable rerouting the PTT signal from footswitch to additional COM-port.
- **Port name** - COM-port number.
- **DTR/RTS** - COM-port line for receiving the PTT commands.
Set one of the **DTR/RTS line** checkbox to select them as control.

5.3.4.2 RX2 receiver

RX2 tab contains a CAT-system settings and control of the transceiver's PTT command via COM-ports for the RX2 receiver.

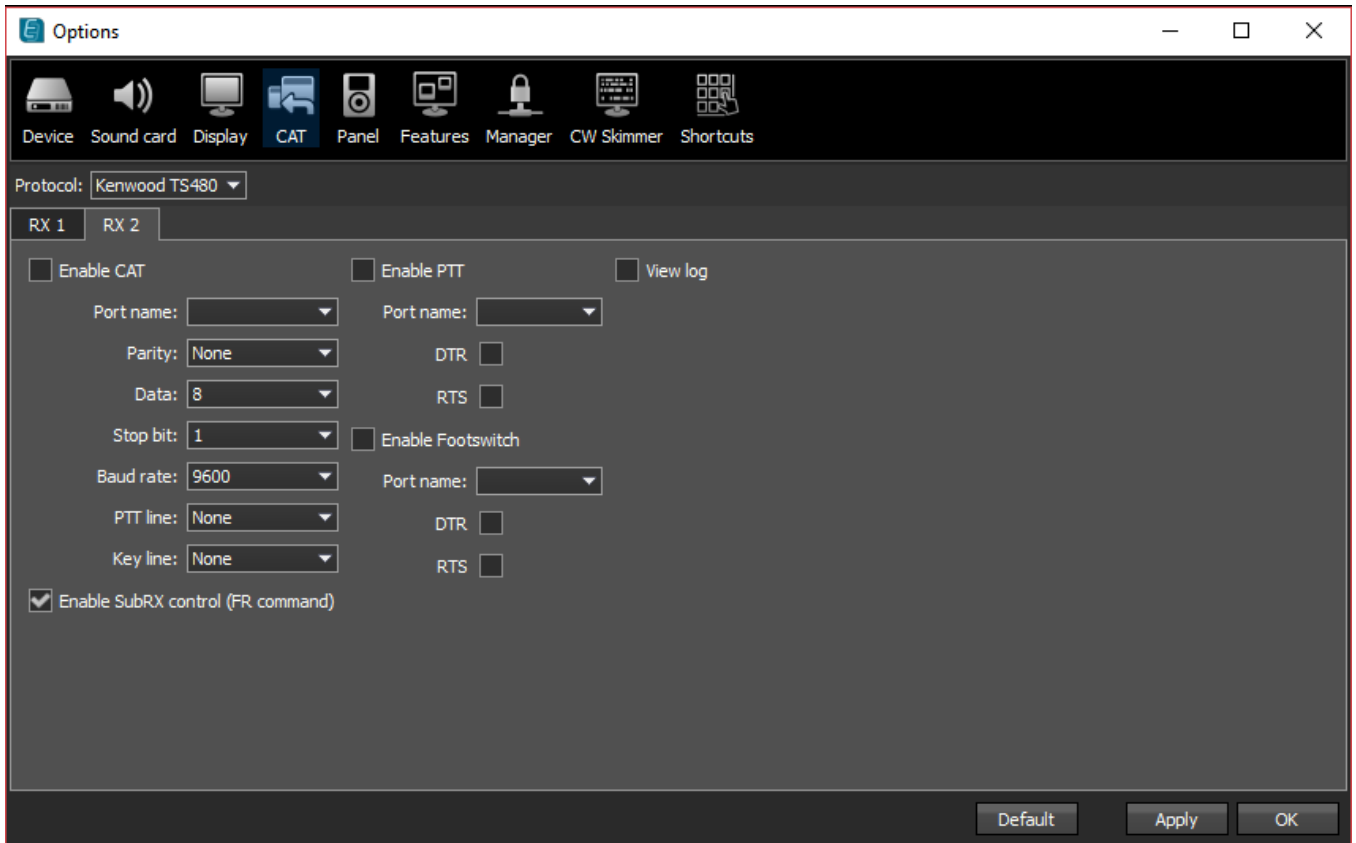

- **Protocol** - Exchange protocol menu with external devices.
Select the required exchange protocol with external devices or software from the list.
- **Enable CAT** - Checkbox to enable control of the transceiver via the CAT-system.
- **Port name** - COM-port number.
- **Parity** - Parity.
- **Data** - Amount of data in bits.
- **Stop bit** - Amount of stop bits.
- **Baud rate** - Port speed.
- **PTT line** - COM-port line to activate the TX mode.
- **Key line** - COM-port line for the CW mode.
- **DTR/RTS** - COM-port line for the PTT mode.

- **Enable SubRX control (FR command)** - Checkbox to enable control of the sub-receiver via the CAT-system.
Set the **Enable SubRX control (FR command)** checkbox to enable the control of the sub-receiver via the CAT-system.
- **Enable PTT** - Checkbox to enable control of the TX mode via the COM-port.
Set the **Enable PTT** checkbox to enable the control of the TX mode via the COM-port.
- **Port name** - COM-port number.
- **DTR/RTS** - COM-port line for receiving the PTT commands.
Set one of the **DTR/RTS line** checkbox to select them as control.
- **Enable Switch** - Checkbox to enable control of rerouting the PTT signal from footswitch to additional COM-port.
Set the **Enable PTT** checkbox to enable rerouting the PTT signal from footswitch to additional COM-port.
- **Port name** - COM-port number.
- **DTR/RTS** - COM-port line for receiving the PTT commands.
Set one of the **DTR/RTS line** checkbox to select them as control.

5.3.4.3 OmniRig

In the **OmniRig** menu you can find the settings of the OmniRig software, MB1 transceiver exchange data with external devices and software through it.

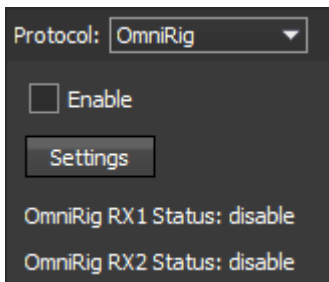

- **Enable** - Checkbox to enable control of the transceiver via the OmniRig software. Set the **Enable** checkbox to enable control of the transceiver via the OmniRig software.
- **Settings** - Button to open the OmniRig software settings for adjustment. Press the **Settings** button to open the OmniRig software settings.

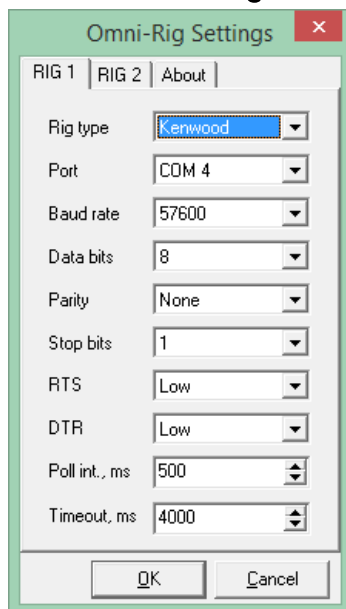

Note:

 If the transceiver's software ExpertSDR2 uses OmniRig protocol to exchange data with external contest log software, which also uses OmniRig, then COM-port and other settings in the OmniRig software are not required. Select in the OmniRig settings any idle COM-port in the system, to avoid conflict.

- **OmniRig RX1 Status** - RX1 receiver and OmniRig connection status.
- **OmniRig RX2 Status** - RX2 receiver and OmniRig connection status.

5.4 Panel menu

In the **Panel** menu you can see the settings of the E-Coder control panel.

In the drop-down Device menu you can select the type of the connected control panel. In the meantime only one type is available - E-Coder.

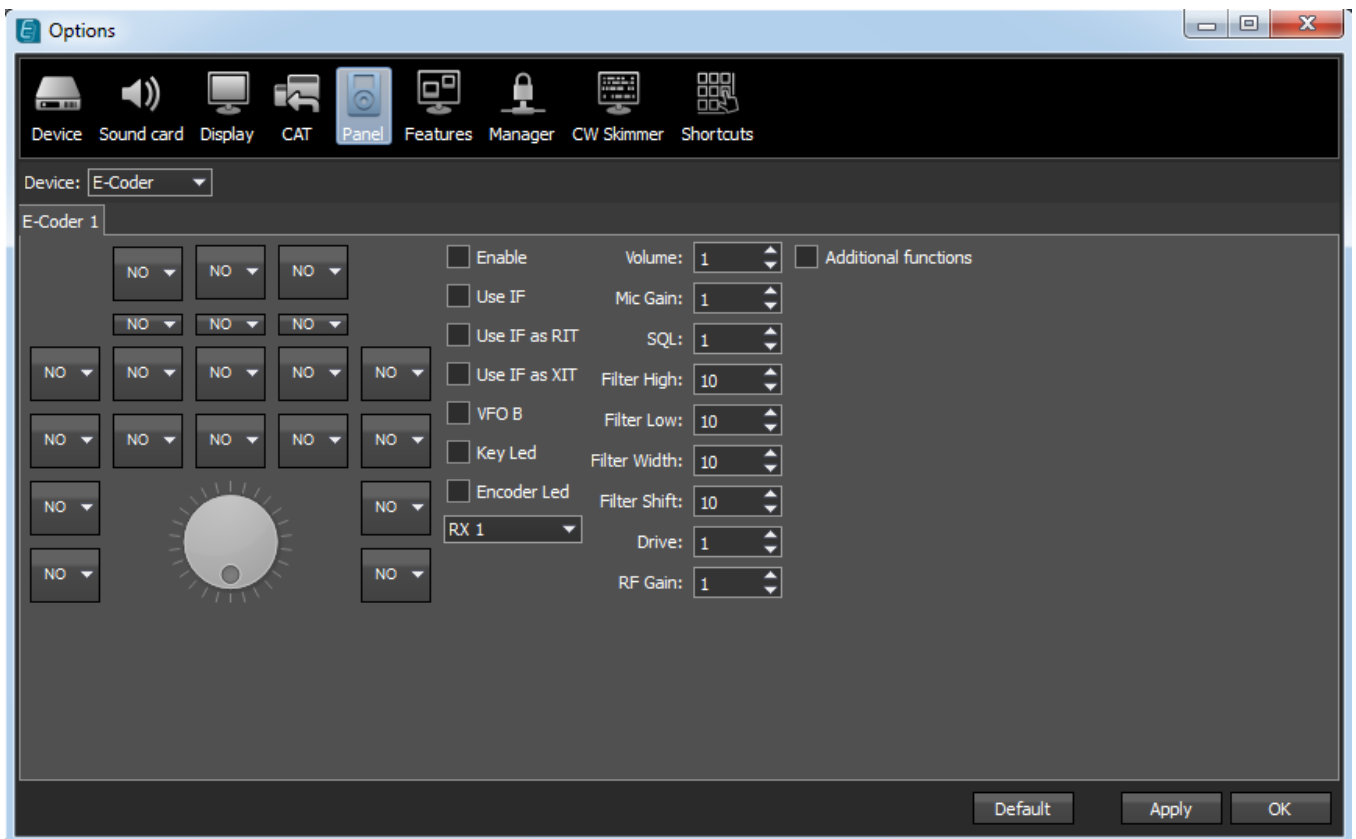

Note:

 If one E-Coder panel is connected to the transceiver in the **Panel** menu displayed one **E-Coder 1** tab, if a several E-Coder panels are connected to the transceiver in the **Panel** menu displayed a several tabs **E-Coder 1**, **E-Coder 2** etc. with identical settings for each panel.



In the left part of the menu you can see the schematic picture of the E-Coder panel with buttons and knobs. Press any button, you'll see the list of the available functions.

Note:

-  The list of the available functions is constantly growing. Keep track of the software updates.
-  You can make a request to add a new function on the control button.

For the buttons - available the following functions:

- **Unused** - button is unused.
- **Band Up/Down** - band switching.
- **Mode Up/Down** - mode switching.
- **Volume Up/Down** - volume adjustment.
- **Mute** - switch off sound.
- **BIN** - enable/disable binaural mode.
- **NR** - enable/disable noise reduction.
- **ANF** - enable/disable analog pick filter.
- **NB1** - enable/disable noise blanker 1.
- **NB2** - enable/disable noise blanker 2.
- **Filter Up/Down** - receiver's filter switching.
- **SQL** - enable/disable squelch.
- **PA** - enable/disable power amplifier.
- **AGC Up/Down** - AGC type switching.
- **Preamp Up/Down** - preamp or attenuator level switching.
- **Step Up/Down** - tuning step adjustment.
- **Zoom In/Out** - spectrum zoom modes switching.
- **MOX** - enable/disable manually operated transmit mode.
- **Tone** - enable/disable tone signal in TX mode.
- **WF** - enable/disable Wide Filter. Filter for all Nyquist zone. If in the **Device** menu settings you set **Auto enable** checkbox, then you don't need this function on the panel.
- **Power ON/OFF** - transceiver's power on/off.
- **Switch DDS/IF** - tuning the frequency by moving the filter over the panorama, in other words changing the digital IF, or when filter stands still and spectrum moves, this is the central frequency tuning.
- **Switch Receiver** - switching between software RX1 and RX2. Main knob will tune the frequency of one of the receivers.
- **Change VFO A/VFO B** - switching between VFO A and VFO B.
- **On/Off Sub RX** - enable/disable SubRX.
- **RIT On/Off** - enable/disable RIT offset.
- **RIT Reset** - reset RIT offset to 0.
- **IF as RIT** - tune the RIT offset by moving the filter over the panorama.

- **XIT On/Off** - enable/disable XIT offset.
- **XIT Reset** - reset XIT offset to 0.
- **Split** - enable/disable Split mode.
- **TX/Play** - turn to TX and play the signal record in air.
- **Voice recording** - enable/disable voice recording.
- **RX ANT** - enable/disable receive antenna.
- **LOCK** - lock the frequency tuning.
- **A>B** - assign the frequency from heterodyne VFO A to heterodyne VFO B.
- **B>A** - assign the frequency from heterodyne VFO B to heterodyne VFO A.
- **B<>A** - frequency exchange between VFO A and VFO B.

For the knobs - available the following functions:

- **Unused** - encoder is unused.
- **Volume** - volume adjustment.
- **Mic Gain** - Mic gain adjustment.
- **SQL** - squelch threshold adjustment.
- **Filter Low/High** - tuning the frequency of the low/high filter's front.
- **Filter Width** - adjusting the filter width.
- **Filter Shift** - shifting the filter's central frequency.
- **Drive** - adjusting the output power.
- **IF** - tuning the frequency by moving the filter over the panorama.
- **RF Gain** - RF Gain control.
- **CW Speed** - CW Speed control.
- **RIT Offset** - adjusting the RIT Offset.
- **XIT Offset** - adjusting the XIT Offset.

In the right part of the menu you can see the main panel settings:

- **Enable** - enable E-Coder panel control.
- **Use IF** - frequency tuning by moving the filter over the panorama.
- **Use IF as RIT** - tuning by IF when the RIT offset is on.
- **Use IF as XIT** - tuning by IF when the XIT offset is on.
- **VFO B** - enable sub-receiver.
- **Key Led** - enable backlit keypad.

- **Encoder Led** - enable backlit encoder.
- **RX1/RX2 menu** - switching between RX1 and RX2 receivers, or assign exact E-Coder panel to your receiver.
- **Volume** - set the volume change step for one knob's clack.
- **Mic Gain** - set the Mic gain change step for one knob's clack.
- **SQL** - set the squelch threshold change step for one knob's clack.
- **Filter High** - set the filter's high limit change step for one knob's clack.
- **Filter Low** - set the filter's low limit change step for one knob's clack.
- **Filter Width** - set the filter's width change step for one knob's clack.
- **Filter Shift** - set the filter's shift change step for one knob's clack.
- **Drive** - set the output level power change step for one knob's clack.
- **RF Gain** - set the RF gain change step for one knob's clack.

Additional functions - Additional panel settings.

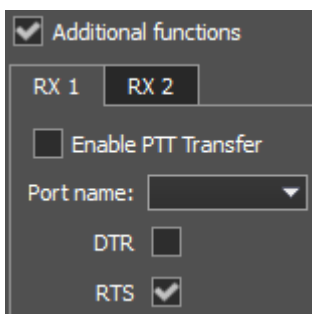

- **RX1/RX2 tab** - Com-port settings tab for rerouting the PTT signal from the panel to the COM-port.
Enable PTT Transfer - Rerouting of the PTT signal from the panel to the COM-port.
Set the **Enable PTT Transfer** checkbox to enable rerouting the PTT signal.
- **Port name** - COM-port number.
- **DTR/RTS** - Select the COM-port line, which is used for transferring the PTT commands.
Set one of the DTR/RTS line checkbox to set it as the control line.

5.5 Features menu

In the **Features** menu you can see the settings to launch other programs along with the transceiver software.

This feature allows you to launch required programs by launching the transceiver software.

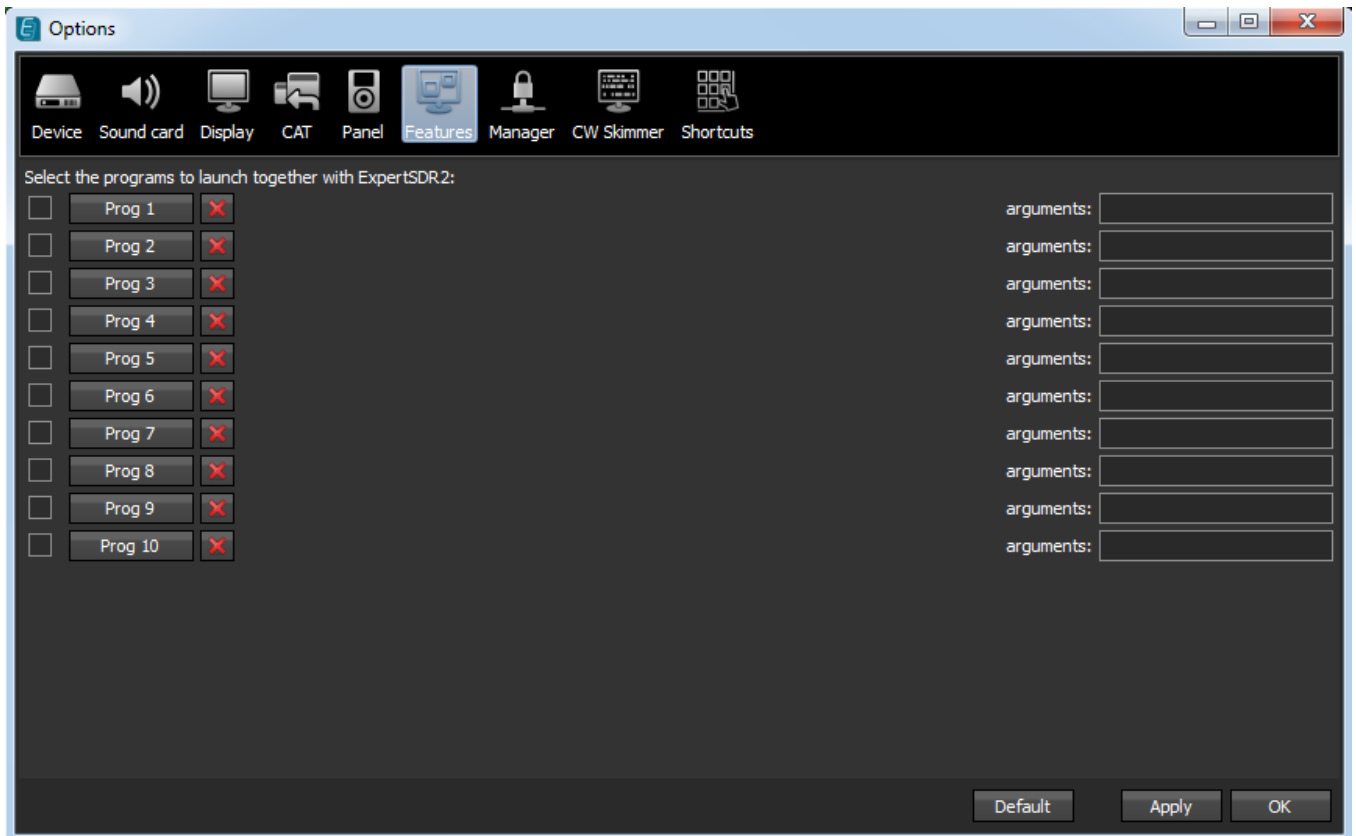

Enable checkbox - Enable program autorun in the list.

Set the **Enable** checkbox in front of the corresponding program in the list.

Program 1-10 - program's button.

Press the **Prog X** button to open the window and select .exe file of the required program.

Delete button - Program delete button.

Press the **Delete** button if you need to delete a program from the autorun list.

Arguments - Input box to enter the argument after program's launch.

Enter some text message in the **arguments** input box for the corresponding program.

Note:

Arguments allow to the same program to be launched with the different settings files etc.

Read the instruction for the certain software you are going to use, in terms of which arguments are supported.

5.6 Manager menu

In the **Manager** menu you can see the settings of the network synchronization between the transceiver and other Expert Electronics devices.

This interface allows you to synchronize the tuning frequency and mode type between several Expert Electronics devices via the ExpertSync software ([you may download it from here](#)).

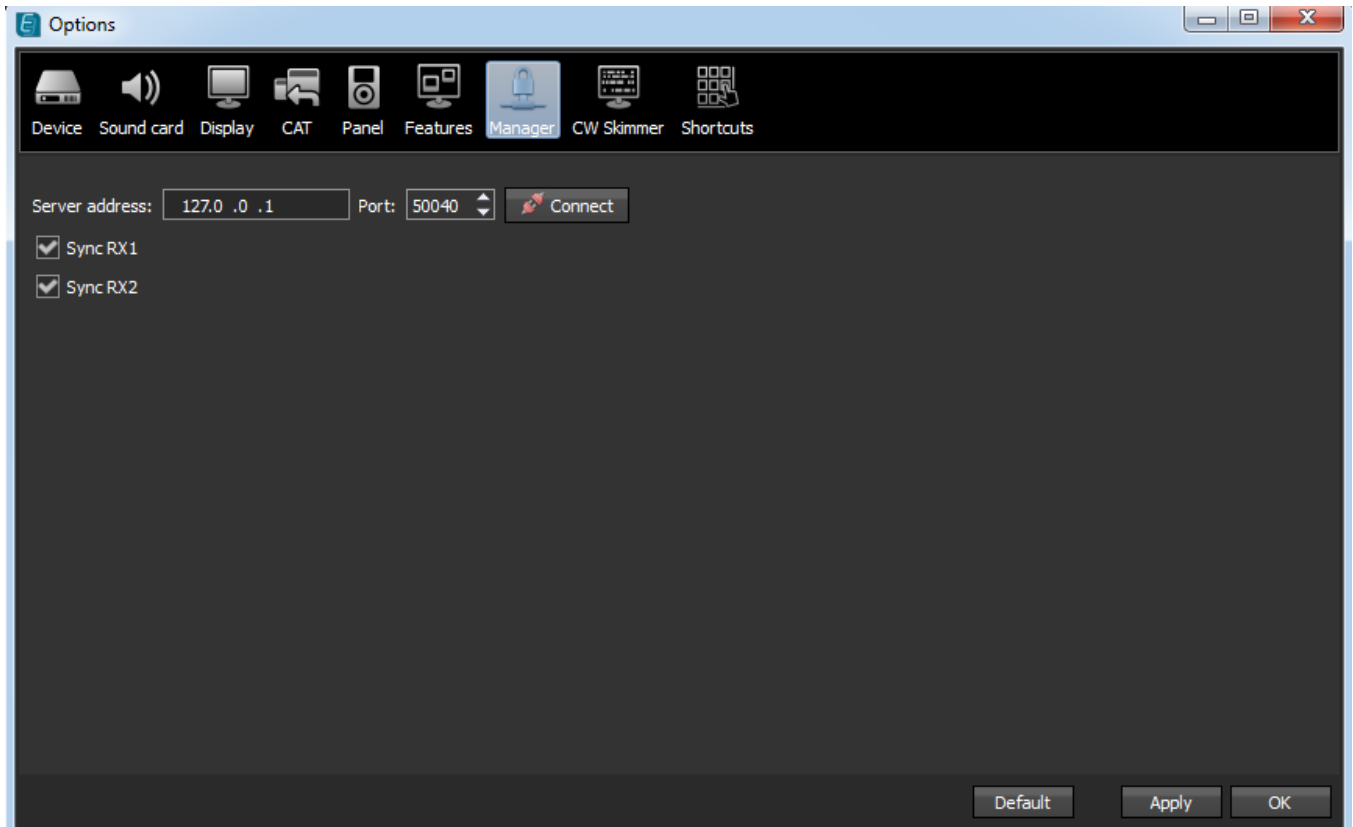

- **Server address** - Input box for the ExpertSync server IP address.
Enter the ExpertSync server IP address. If the the ExpertSync server is launched on the transceiver's PC, then the address will be 127.0.0.1.
- **Port** - Input box of the data exchange port.
Enter the exchange port number in the **Port** input box.
- **Connect** - Button to launch the connection between the transceiver's software and ExpertSync.
Press the **Connect** button to launch the connection between the transceiver's software and ExpertSync. Blue indicator means there is a connection.
- **Sync RX1** - RX1 receiver sync button.
Set the **Sync RX1** checkbox to synchronize RX1 receiver with remote RX1 receiver.
- **Sync RX2** - RX2 receiver sync button.
Set the **Sync RX2** checkbox to synchronize RX2 receiver with remote RX2 receiver.

5.7 CW Skimmer menu

In the **CW Skimmer** menu you can see the connection settings between the transceiver software and CW Skimmer software or Internet server-spotter.

Settings in the **CW Skimmer** menu has two identical tabs RX1 and RX2 with connection settings for each software receiver, let's take a look at one of them.

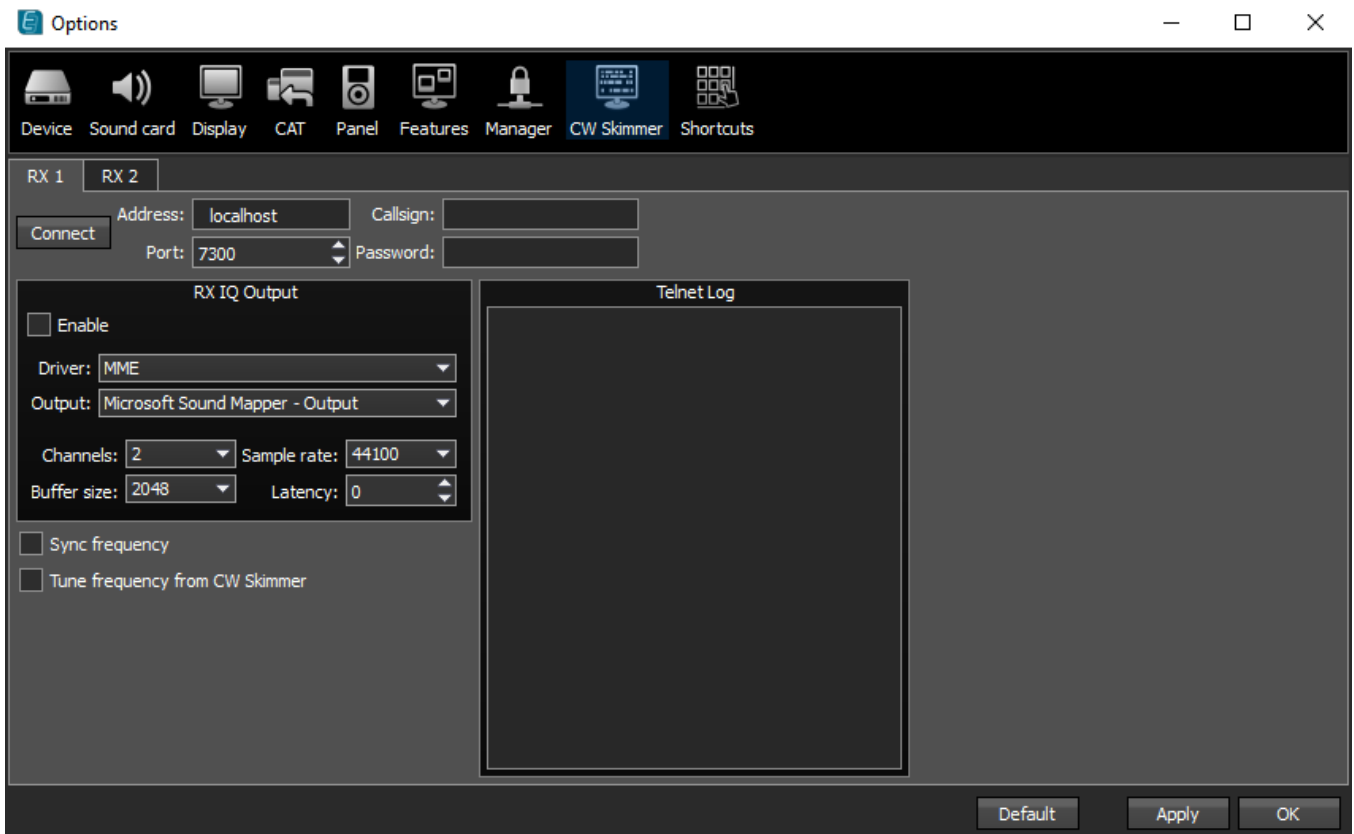

- **Connect** - Button to launch the connection with the CW Skimmer software or Internet server-spotter.
Press the **Connect** button, after adjusting all settings, to make a connection with the CW Skimmer software or Internet server-spotter.
- **Address** - IP address or DNS name of the CW Skimmer/server.
Enter this 127.0.0.1 address or localhost, if you want to connect to the CW Skimmer, which is installed on the transceiver's PC.
- **Port** - Input box of the data exchange port.
Enter the exchange port number in the **Port** input box.
- **Callsign** - Callsign input box.
Enter your callsign if the server requires it.
- **Password** - Password input box.
Enter the password if the server requires it.

To transfer the IQ signal in the CW Skimmer you need to adjust the settings of the audio device in the **RX IQ output** category, it consists of:

- **Enable** checkbox - Enable the IQ signal transfer from the EperSDR2 to the CW Skimmer.
- **Driver** - audio device driver type.
- **Output** - audio device physical output.
- **Channels** - amount of the used channels of the audio device.
- **Sample rate** - sampling frequency.
- **Buffer size** - buffer size.
- **Latency** - signal delay time.

Note:

 *If CW Skimmer is installed on the transceiver's PC, then for the signal output you need to use Virtual Audio Cable.*

- **Sync frequency** - ExpertSDR2 set the CW Skimmer frequency.
- **Tune frequency from CW Skimmer** - CW Skimmer set the ExpertSDR2 frequency.

5.8 Shortcuts menu

In the **Shortcuts** menu you can see the shortcut key combinations settings.

With the help of the key combinations you can control the transceiver from your keyboard.

Note:

 **Shortcuts** will be active only if the transceiver's software window is in focus.

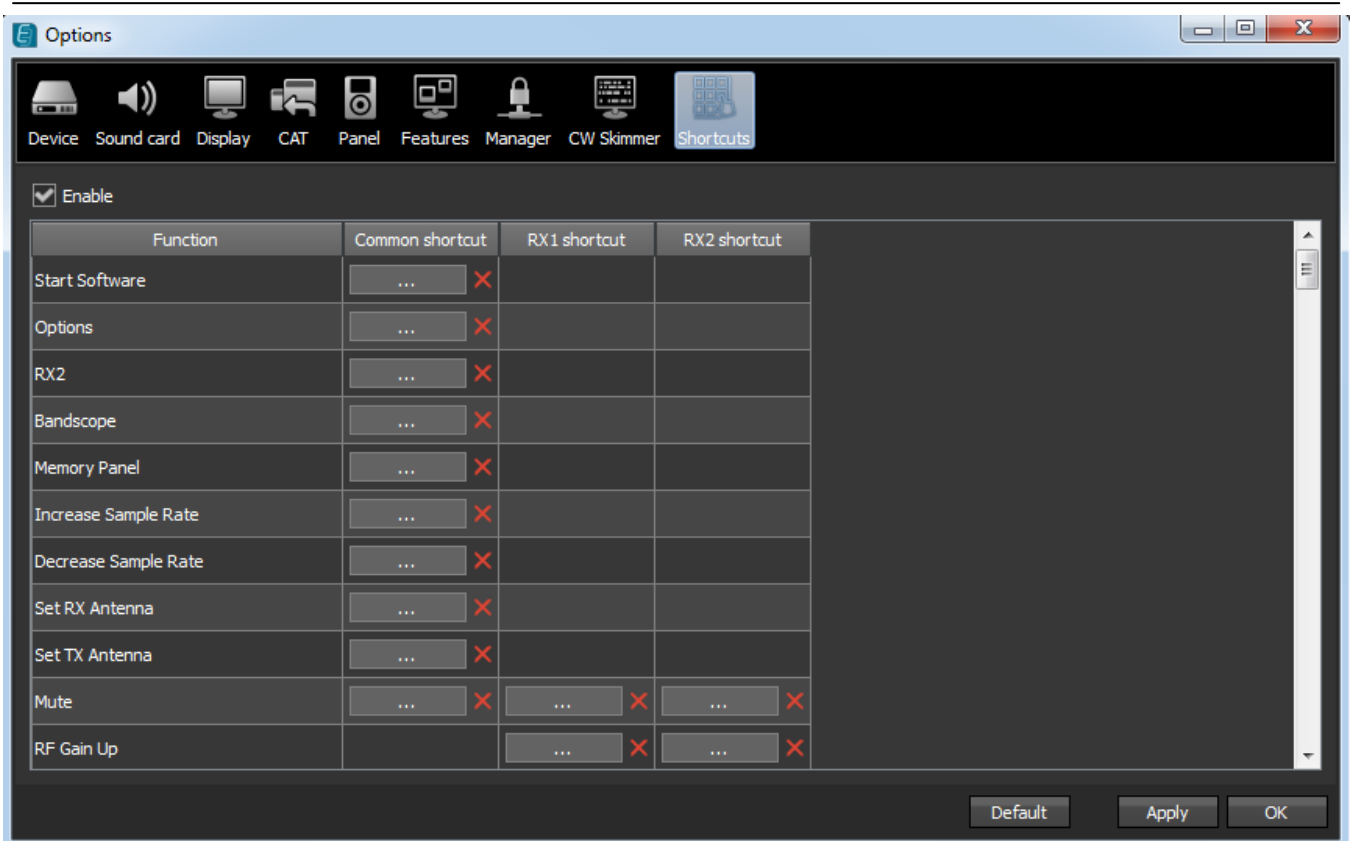

- **Enable** - Shortcuts enable button.
Set the **Enable** checkbox to activate assigned shortcuts.
- **Function** - Transceiver's functions column.
In the **Function** column displayed all transceiver's functions available for shortcuts.
- **Common shortcut** - Column with the main shortcuts.
In the **Common shortcut** column you can set the main transceiver's functions.
- **RX1 shortcut** - RX1 receiver shortcuts column.
In the **RX1 shortcut** column you can set RX1 receiver functions.
- **RX2 shortcut** - RX2 receiver shortcuts column.
In the **RX2 shortcut** column you can set RX2 receiver functions.
-  - Shortcut button.
Press the **Shortcut button**, then press the key combination on the keyboard.

-  - Delete shortcut button.

Press the **Delete shortcut button** near the shortcut you want to delete.

5.9 MB1 Utility

MB1 Utility is the support program which is constantly active along with the main ExpertSDR2-MB1 software. It's purpose is to collect system sensor's data and control rerouting of the sound paths of the audio switch.

MB1 Utility works in a minimized mode in a system tray (right, button corner of the display).

MB1 Utility has the following tabs:

5.9.1 Main

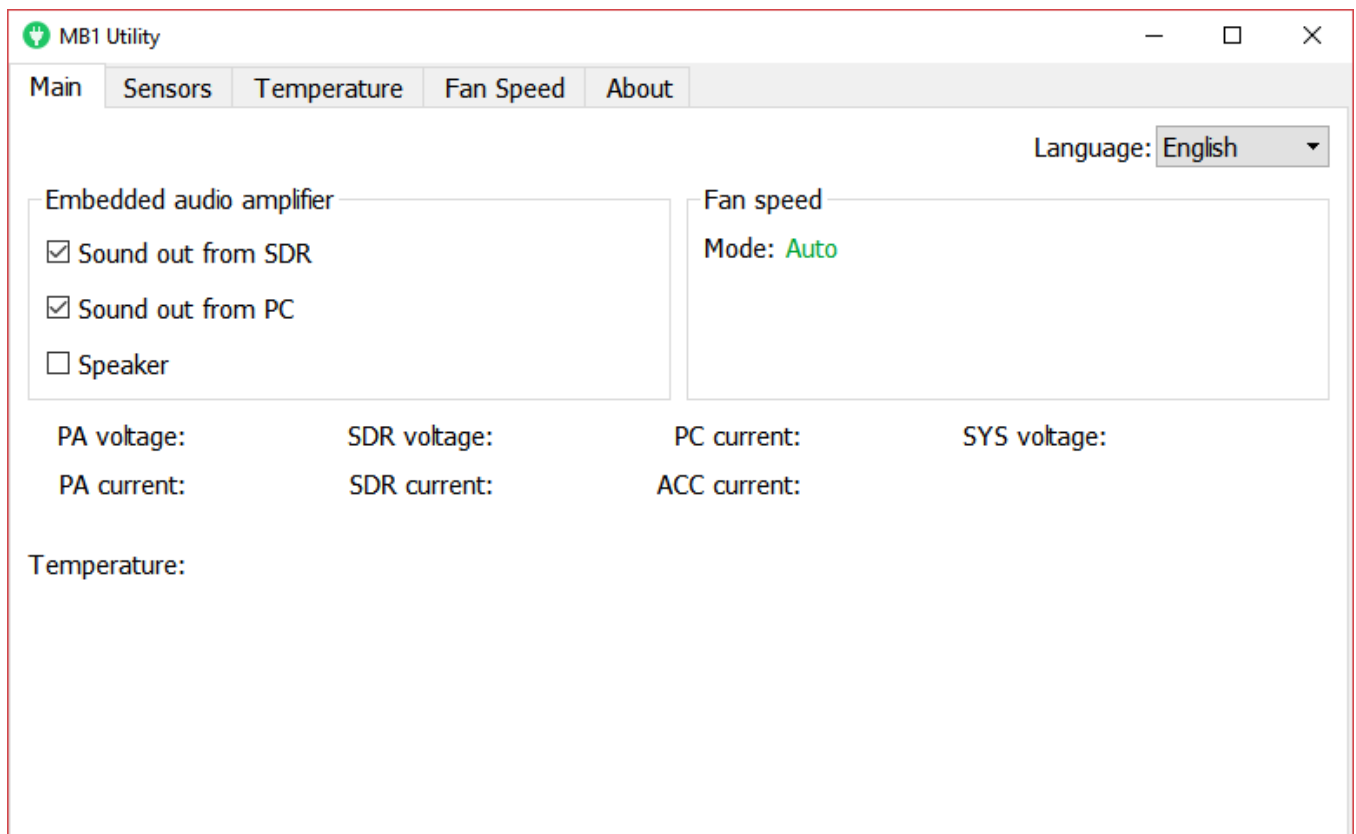

Language - Language menu of the MB1 utility.

Select the required interface language. Two languages are available: Russian and English.

Embedded audio amplifier category:

Sound out from SDR - Sound output from the SDR-module's codec goes in the mixer.

Set the **Sound out from SDR** checkbox, if you want the sound output from the SDR-module's codec pass in the mixer, to listen to the received signals via the internal speaker and/or headphones via the **PHONES** jack.

Sound out from PC - Sound output from the internal PC goes in the mixer.

Set the **Sound out from PC** checkbox, if you want the sound output from the internal PC pass in the mixer to listen to the received signals via the internal speaker and/or headphones via the **PHONES** jack.

Speaker - Internal speaker checkbox.

Set the **Speaker** checkbox to play sounds via the internal speaker.

Note:

 Checkboxes are doubled by buttons in the software main window in the Mixer local panel (more details in [MIXER](#)⁵⁷). In other words, you don't have to open the MB1 utility to control sound output, you can do it in the EXpertSDR2 software.

Fan speed category.

Mode - Fan mode indicator.

Fan indicator shows current fan mode.

PA voltage - PA voltage indicator.

PA current - PA current consumption indicator.

SDR voltage - SDR-module voltage indicator.

SDR current - SDR-module current consumption indicator.

PC current - PC current consumption indicator.

ACC current - Accessories current consumption indicator.

SYS voltage - Power supply output voltage indicator.

Temperature - Transceiver temperature indicator.

5.9.2 Sensors

On the **Sensors** tab you can see timed voltage and current diagrams.

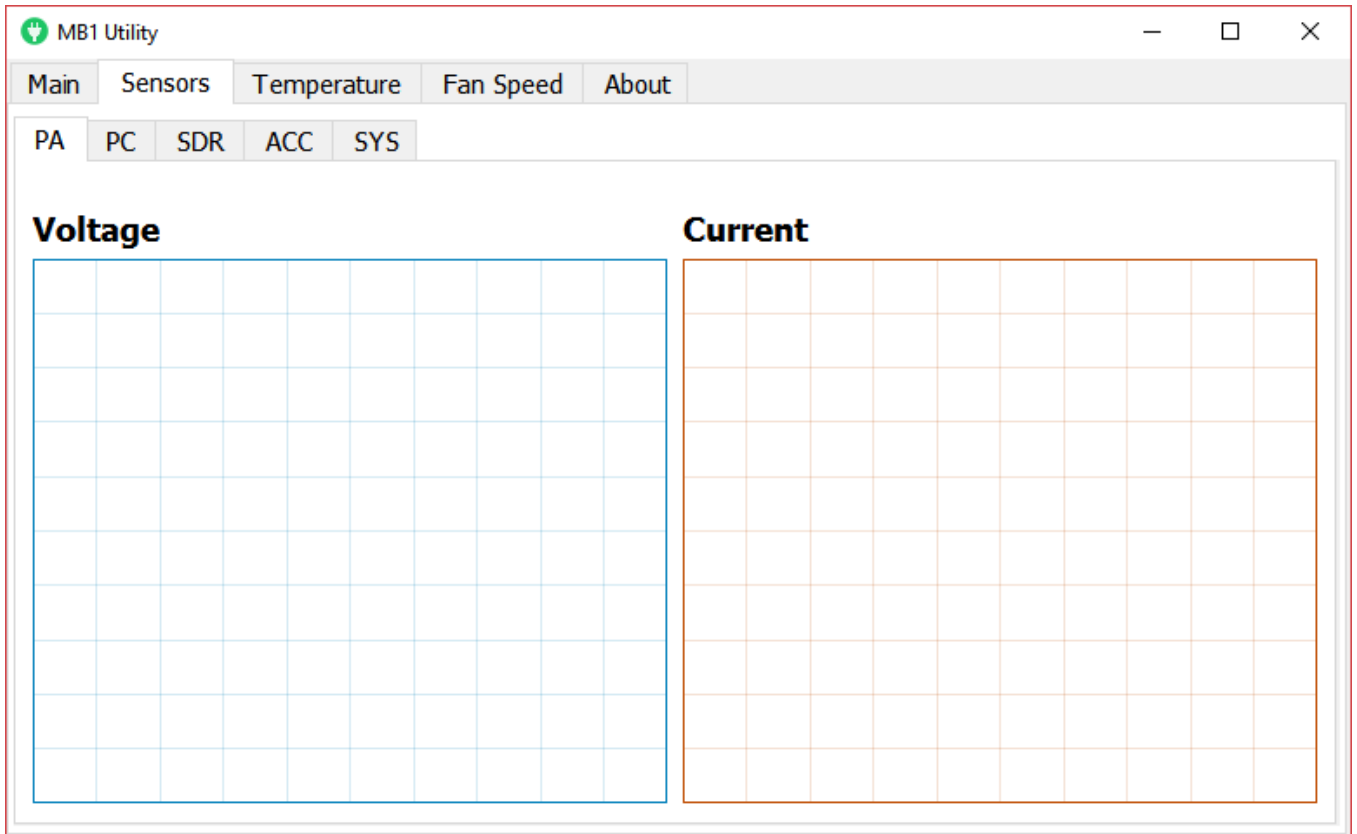

5.9.3 Temperature

On the **Temperature** tab you can see the timed diagram of the temperature sensor.

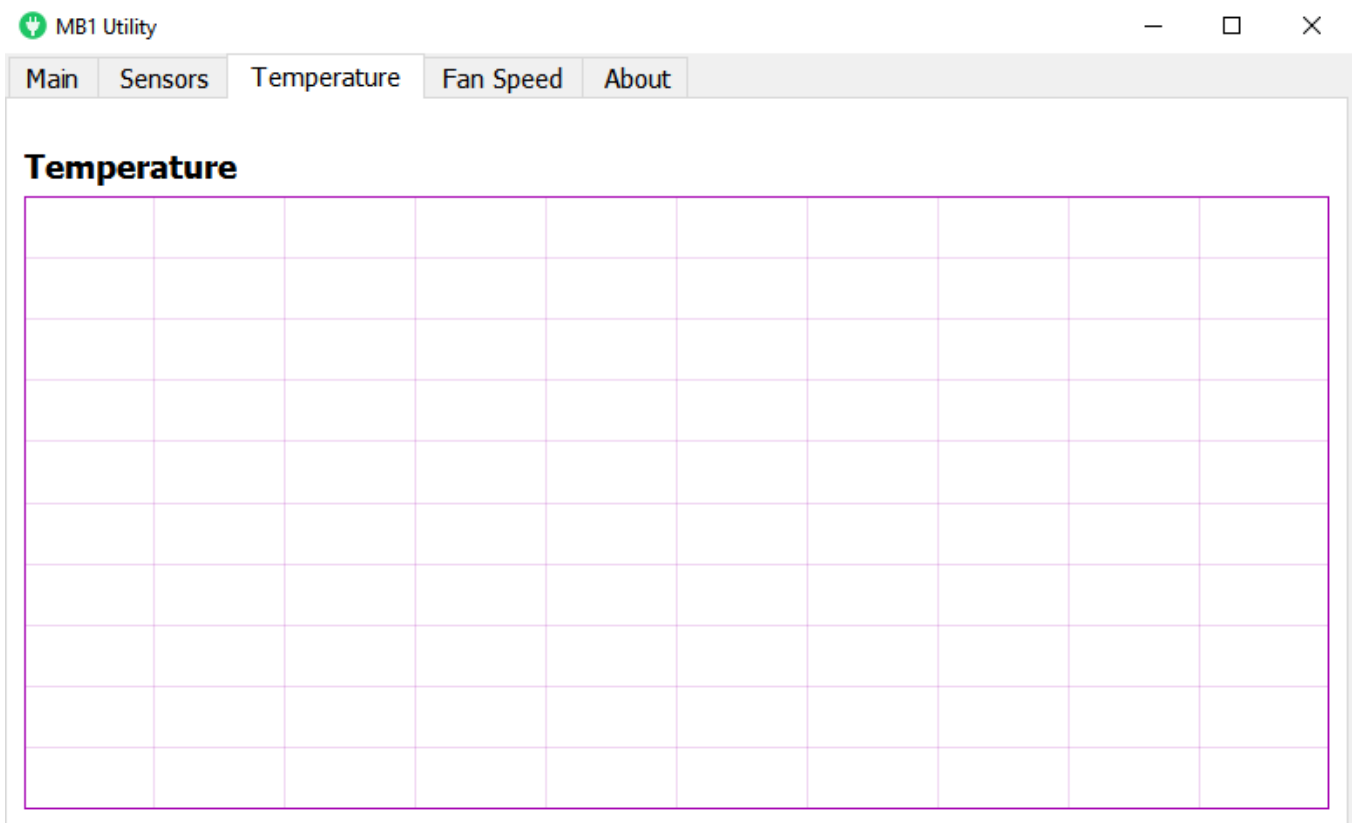

5.9.4 Fan Speed

On the **Fan Speed** tab you can adjust the fan speed settings.

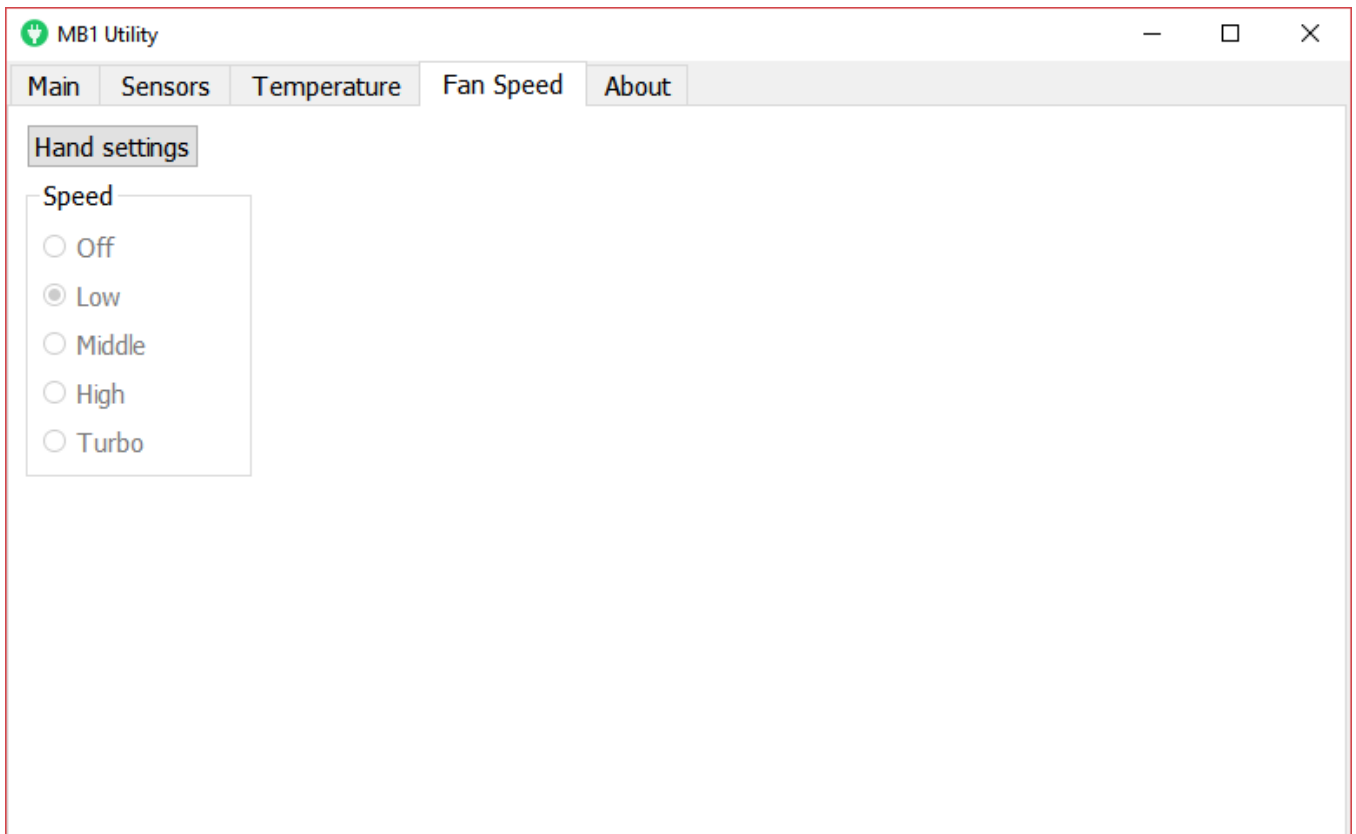

Hand settings - Button to enable manual control of fan speed via presets.

Press the **Hand settings** button to enable manual control of fan speed via presets.

- **Off** - Switch off fan.
- **Low** - Low sound mode.
- **Middle** - Medium fan speed.
- **High** - High fan speed.
- **Турбо** - Max fan speed.

5.9.5 About

On the **About** tab you can see the info about the name, version of the program, and Copyrights.

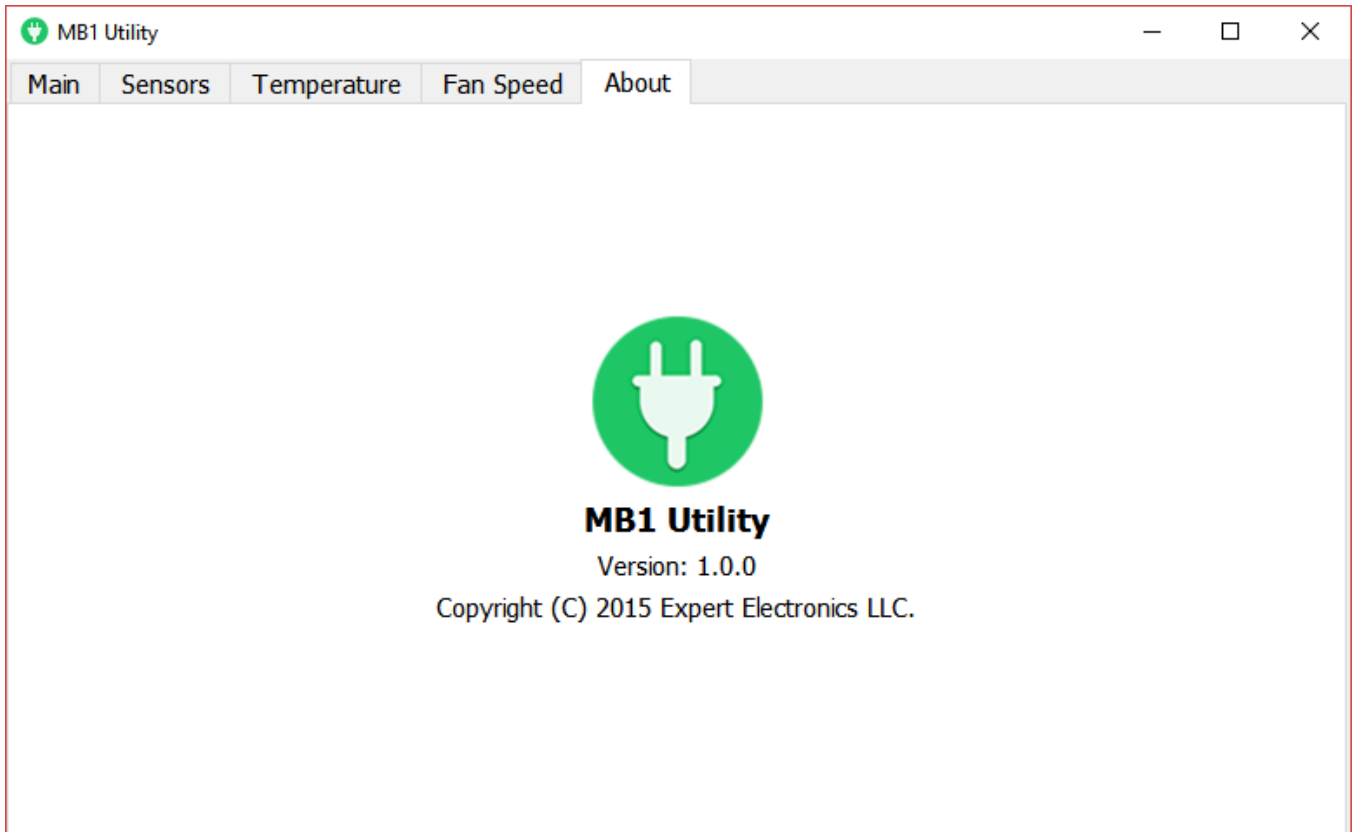

5.10 Windows settings

Make some adjustments in the Windows 10 OS for correct operation of the MB1 transceiver.

Note:

 All required adjustments are performed at the manufacturing.

5.10.1 Date and time settings

Do the following to set the date and time:

1. Click the left mouse button on the **time in tray** (marked with a red rectangle on the picture below).
2. Click the left mouse button on the **Date and time settings** menu (marked with a red rectangle on the picture below).

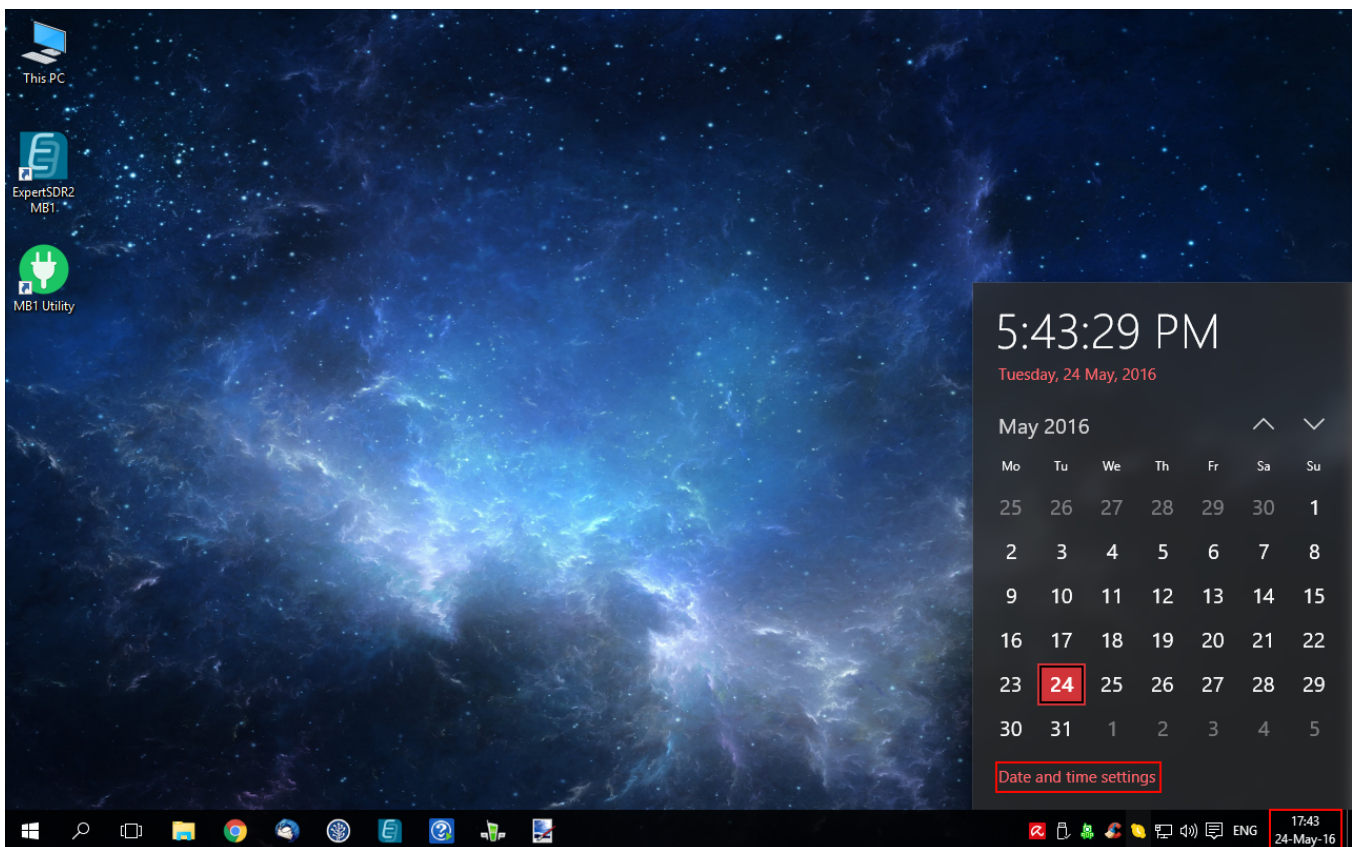

3. In the appeared settings window switch off **Set time automatically** (marked with a red rectangle on the picture below).
4. Select your current **Time zone**.
5. Press the **Change** button (marked with a red rectangle on the picture below).

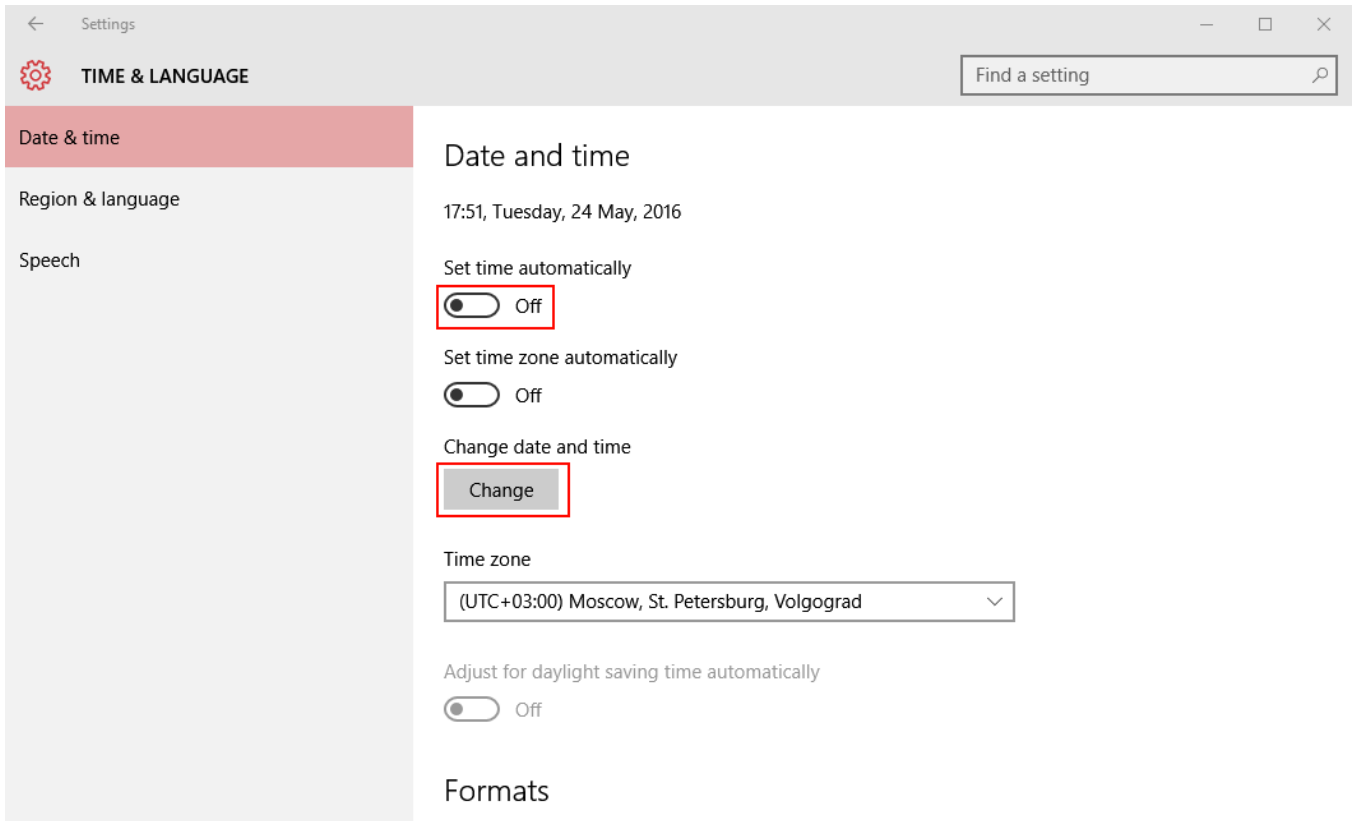

6. In the **Change date and time** menu set current date and time.

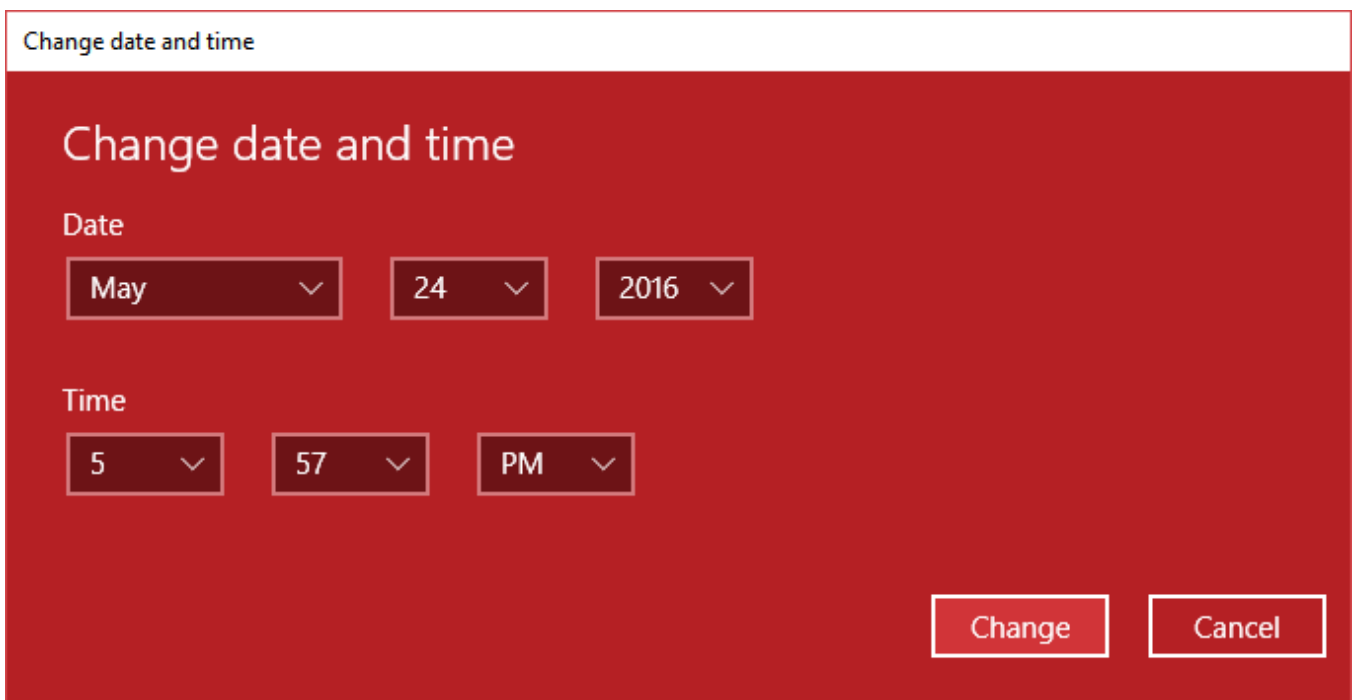

5.10.2 Switch off screen saver

To switch off the screen saver do the following:

1. Click the right mouse button anywhere on the home screen.
2. In the appeared menu select the **Personalize** section, by the click of the left mouse button (marked with a red rectangle on the picture below).

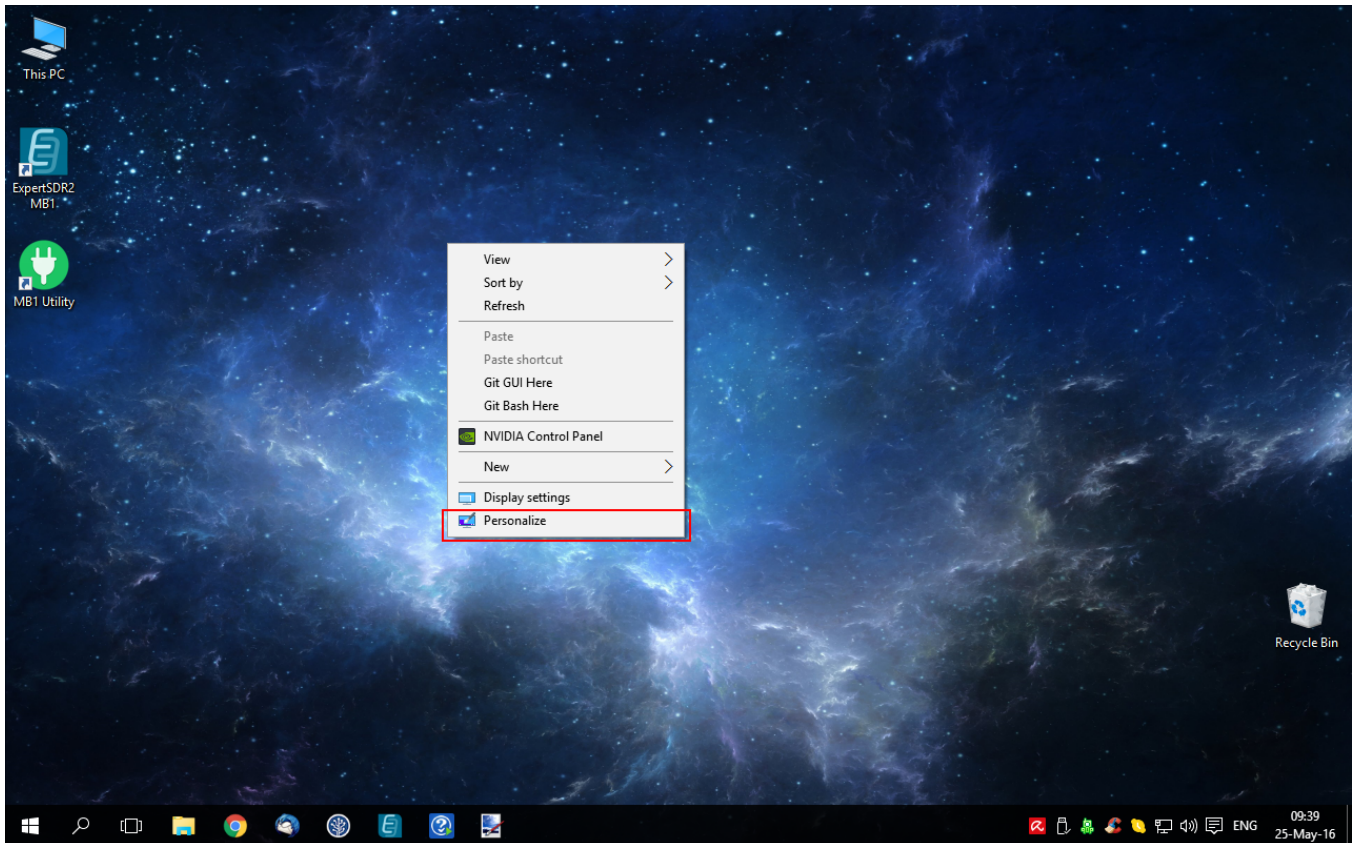

3. In the **Personalization** window select **Lock screen** menu-> **Screen saver settings**, by the click of the left mouse button (marked with a red rectangle on the picture below).

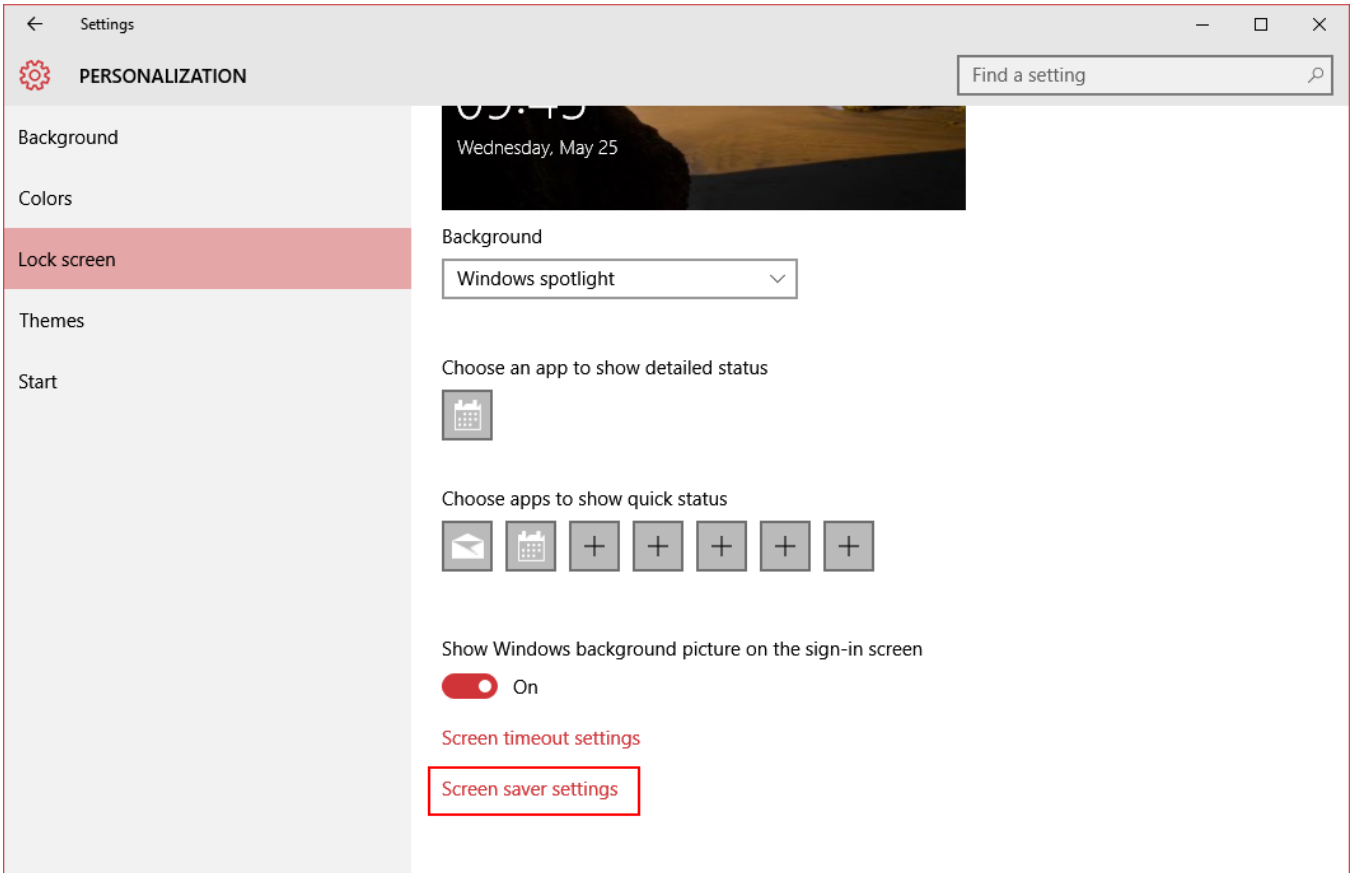

4. In the **Screen saver settings** menu in the **Screen saver** drop-down menu select **(None)**, by the click of the left mouse button (marked with a red rectangle on the picture below).

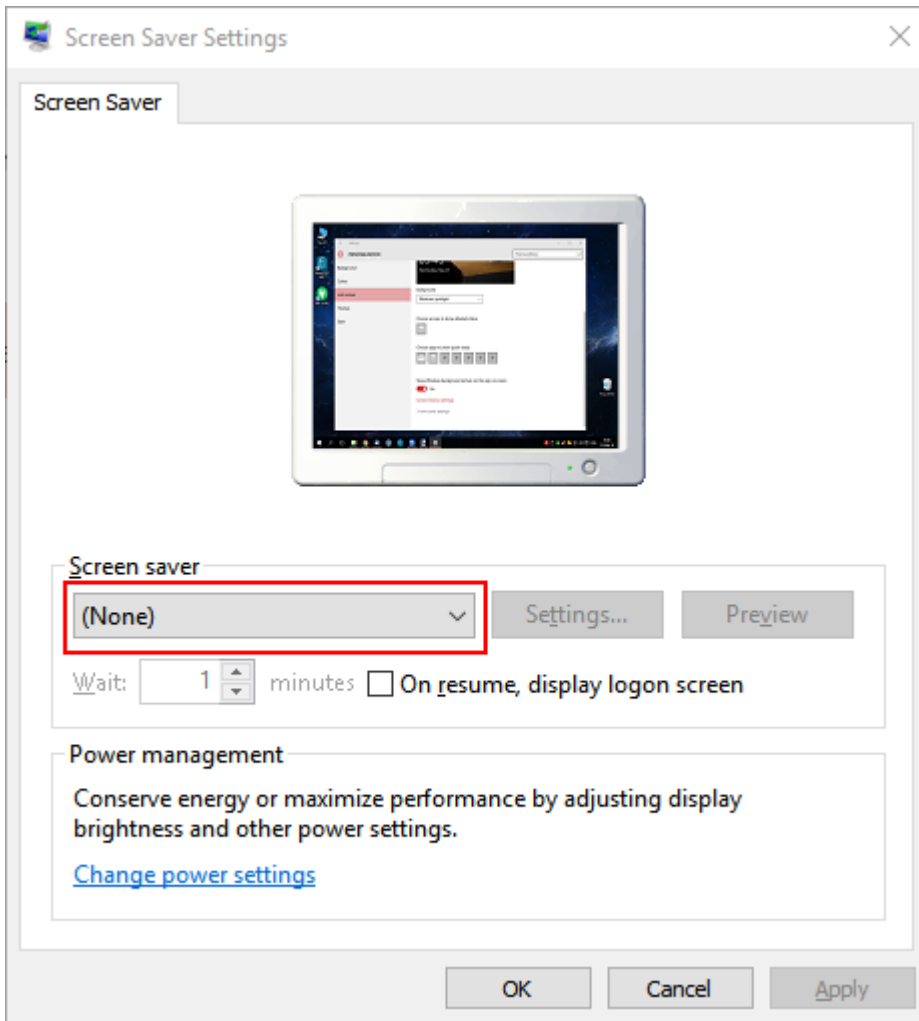

Note:

 If your OS was updated, it might change selected **(None)** value to manufacturer settings. Check this out, and switch off the screen saver again, if necessary.

5.10.3 Switch off sleep mode

To switch off the sleep mode do the following:

1. Open the **Start** menu, by pressing the  in the left bottom corner of the screen.
2. Select **Settings** in the menu (marked with a red rectangle on the picture below).

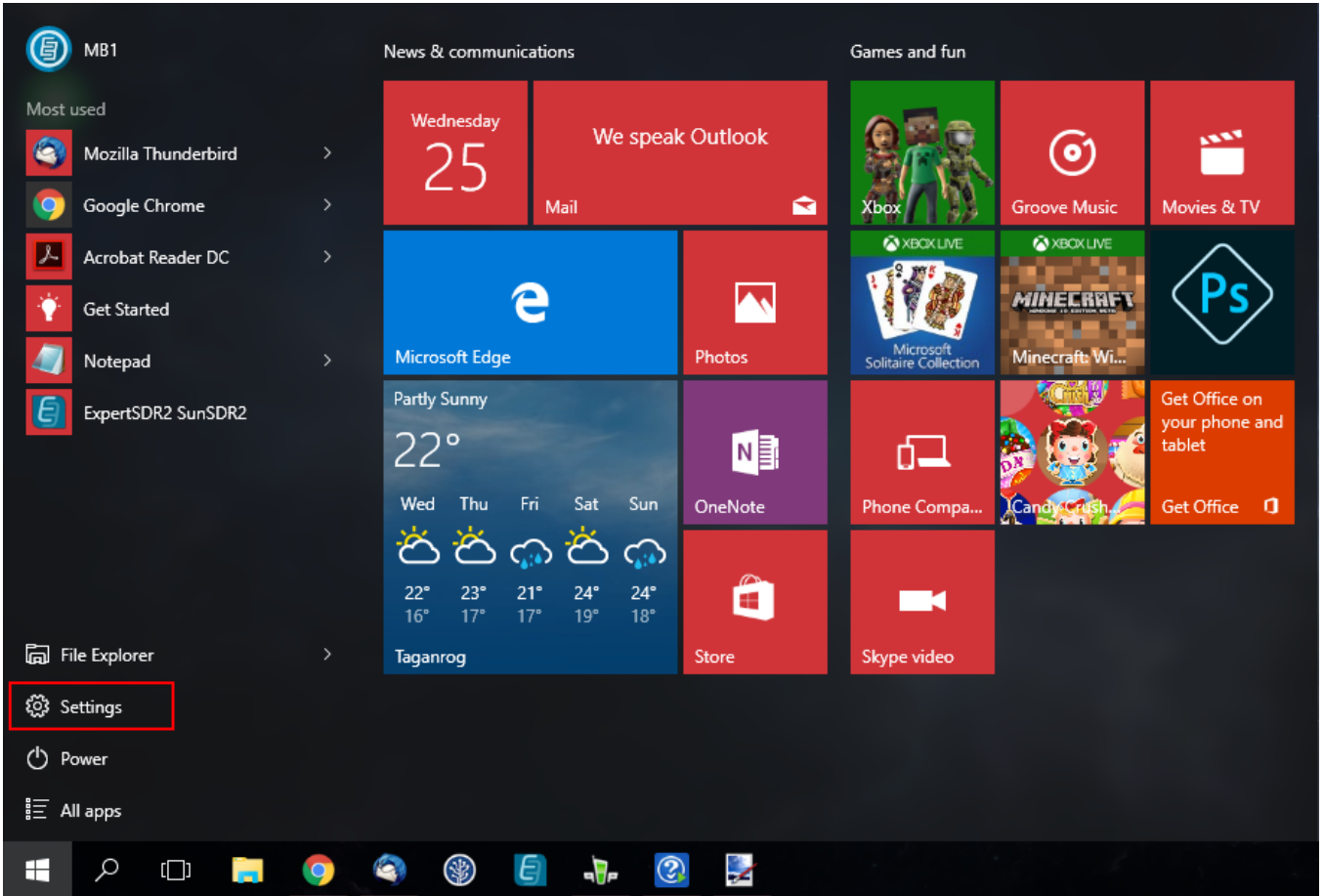

3. In the appeared **Settings** window select the **System** menu by the click of the left mouse button (marked with a red square on the picture below).

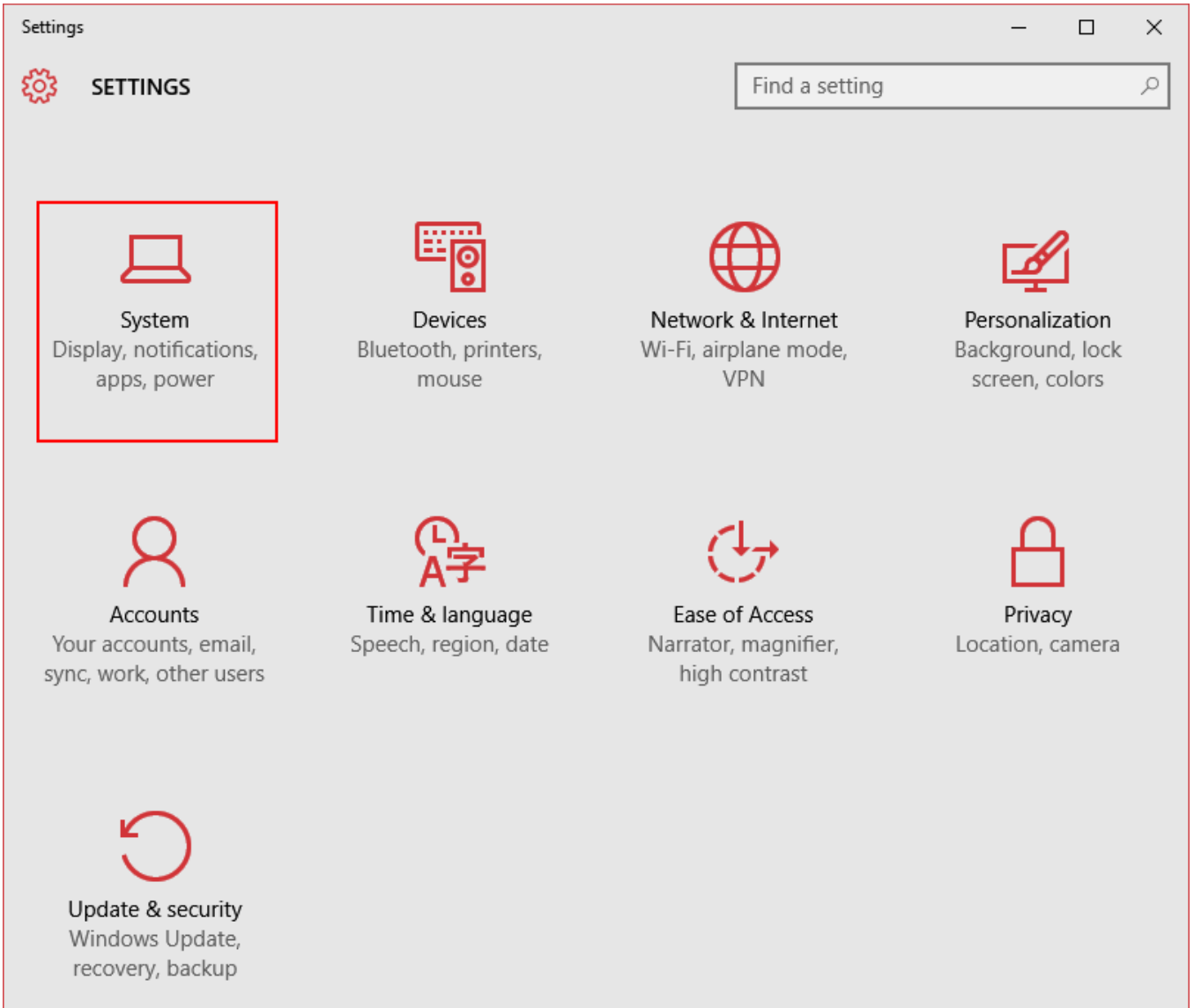

4. In the **System** window select the **Power & sleep** menu by the click of the left mouse button (marked with a red rectangle on the picture below).
5. In the **When plugged in, turn off after** drop-down menu select - **Never**.
6. In the **When plugged in, PC goes to sleep after** drop-down menu select - **Never**.

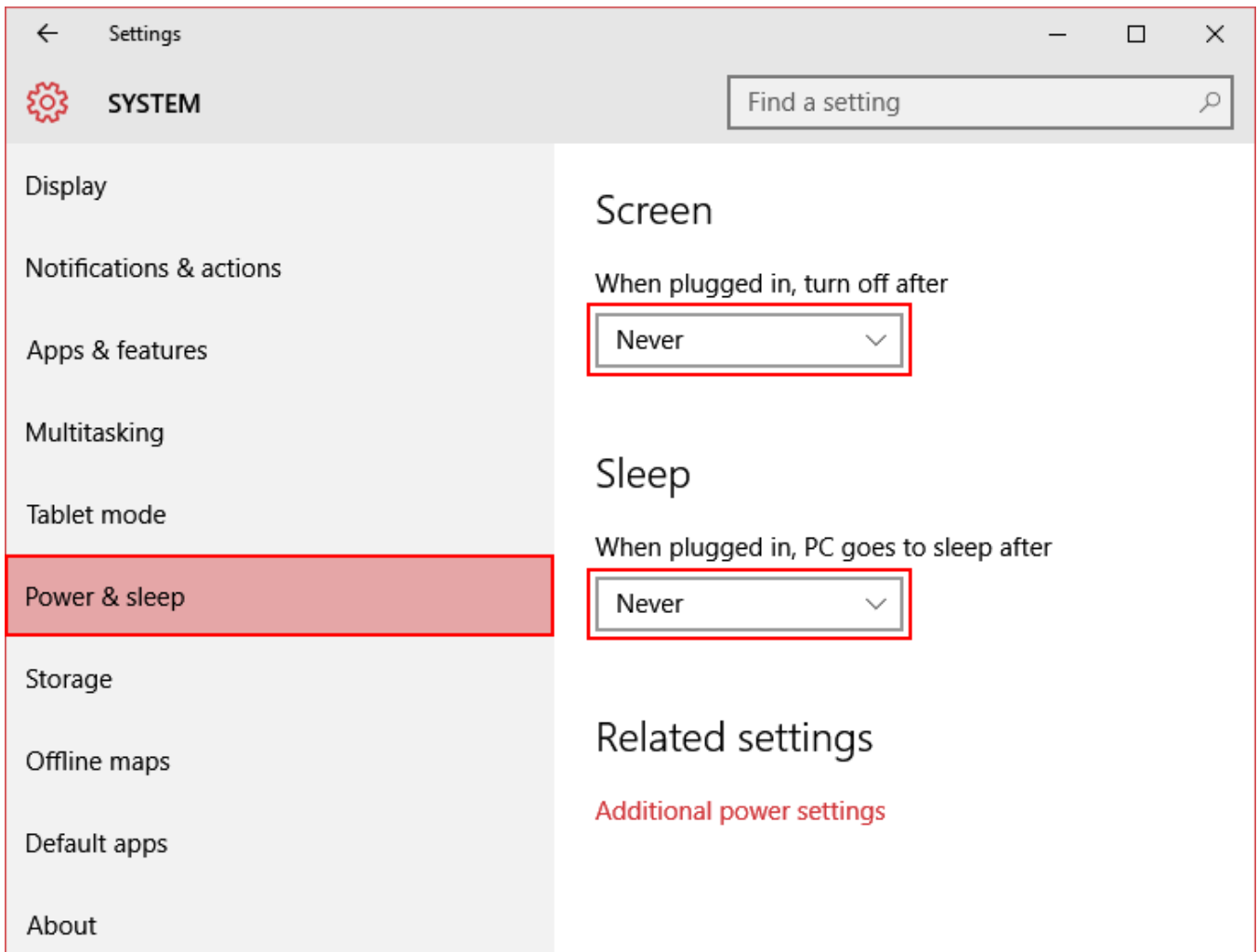
**Note:**

- ☎ If the internal PC went to the sleep mode, after it'll come back transceiver won't function properly. For correct functioning of the transceiver switch it off and then switch on.
- ☎ If your OS was updated, it might change selected (**Never**) value to manufacturer settings. Check this out, and switch off the sleep mode again, if necessary.

5.10.4 Network adapter settings

MB1 transceiver has two network adapters. One network adapter is the USB-LAN adapter called MB1 and is used for connection with the SDR-module.

Internal network adapter should be set according to the following steps:

1. Press the Network  sign in tray.
2. In the appeared window click on the **Network settings** menu (marked with a red rectangle on the picture below).

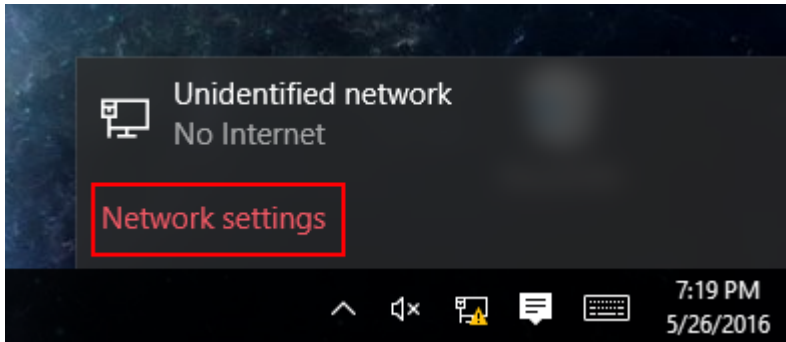

3. In the **Network & Internet** window select **Ethernet-> Change adapter options** (marked with a red rectangle on the picture below).

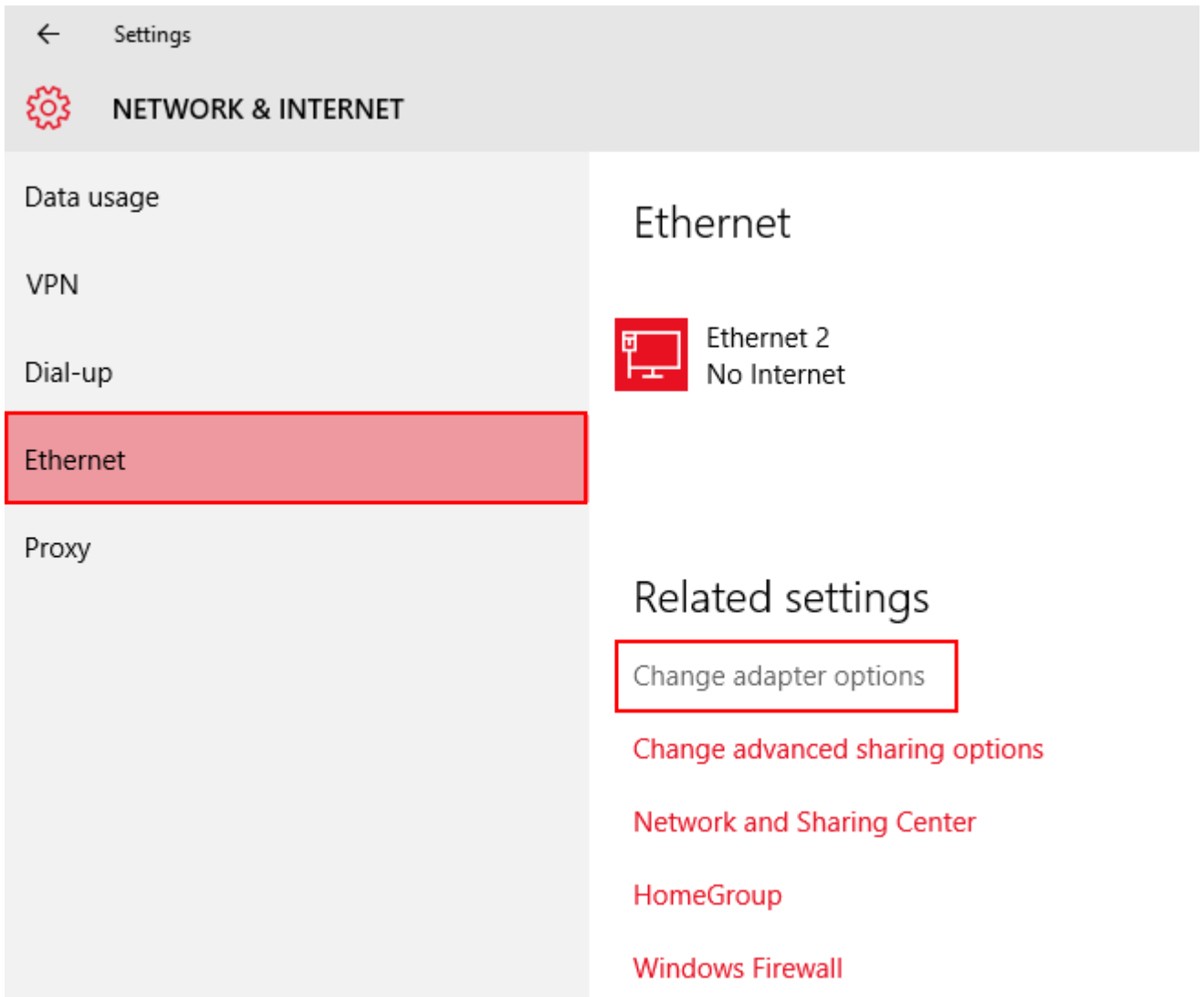

4. In the **Network Connections** window click right mouse button on the **MB1** network icon.

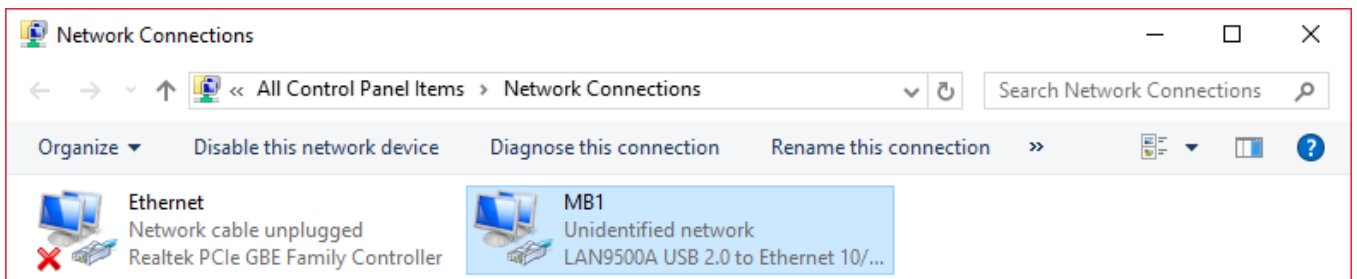

5. In the drop-down menu select **Properties**.

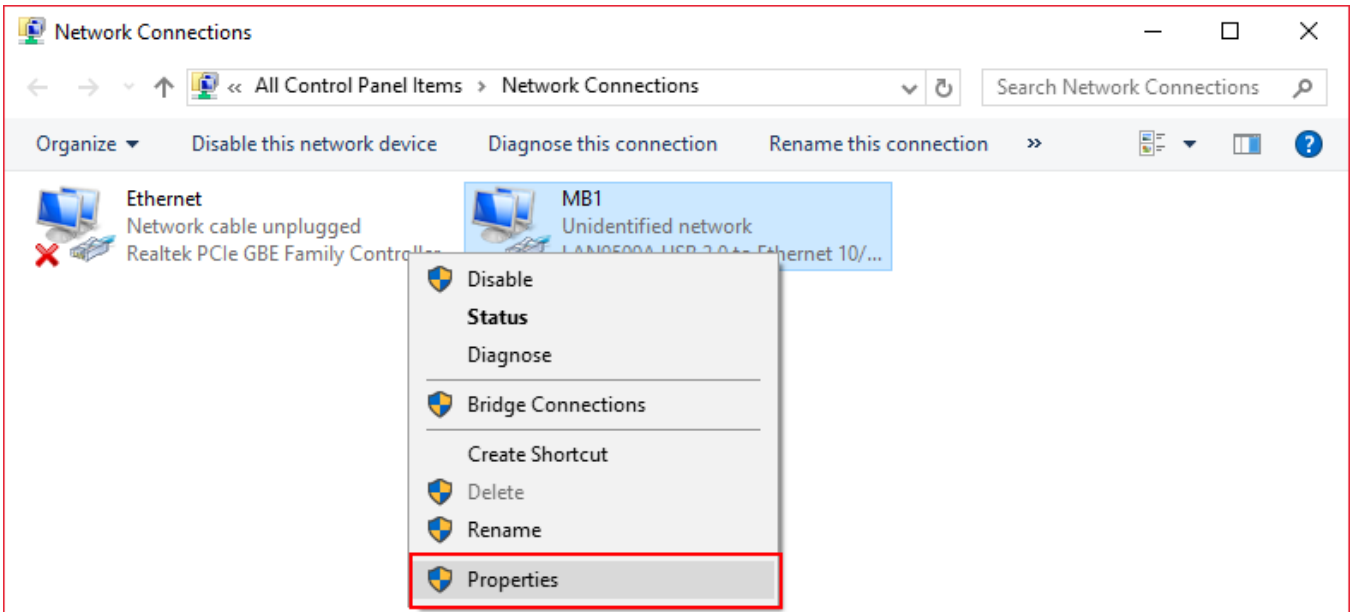

6. In the **MB1 Properties** window select **IP versions 4(TCP/IPv4)** and press **Properties** button.

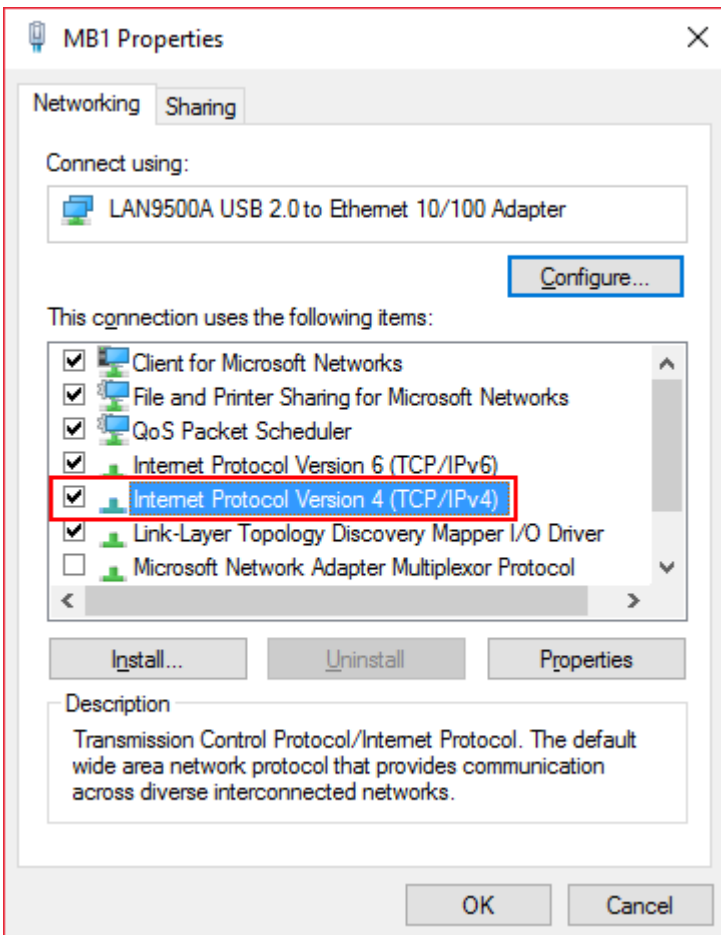

7. In the **IP versions 4(TCP/IPv4) Properties** window set the settings as on the picture below.

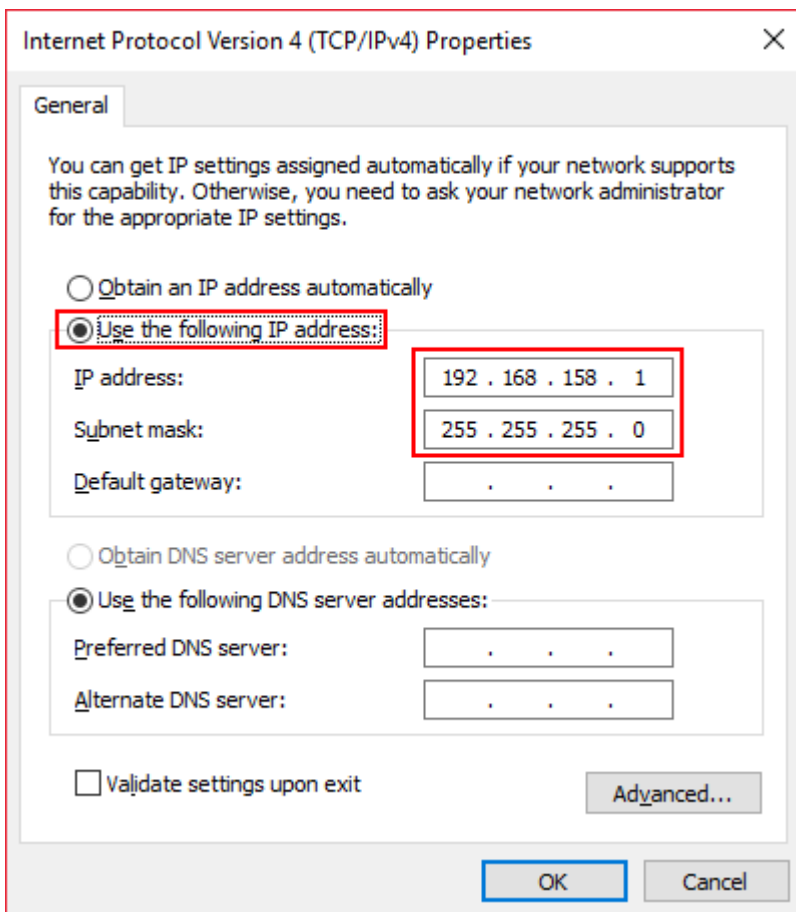

8. Press the **OK** button in this and previous windows.

5.10.5 System recovery

While operating the MB1 transceiver, may occur the situation when the actions either of the user or software could lead to half or full failure of the device functionality.

To protect you device from it, we recommend to create **system restore points** from time to time, which could be used in case of Windows OS failure.

5.10.5.1 Create restore point

To create the restore point do the following:

1. Open the **Start** menu, by pressing the  in the left bottom corner of the screen.
2. Select **Settings** in the menu (marked with a red rectangle on the picture below).

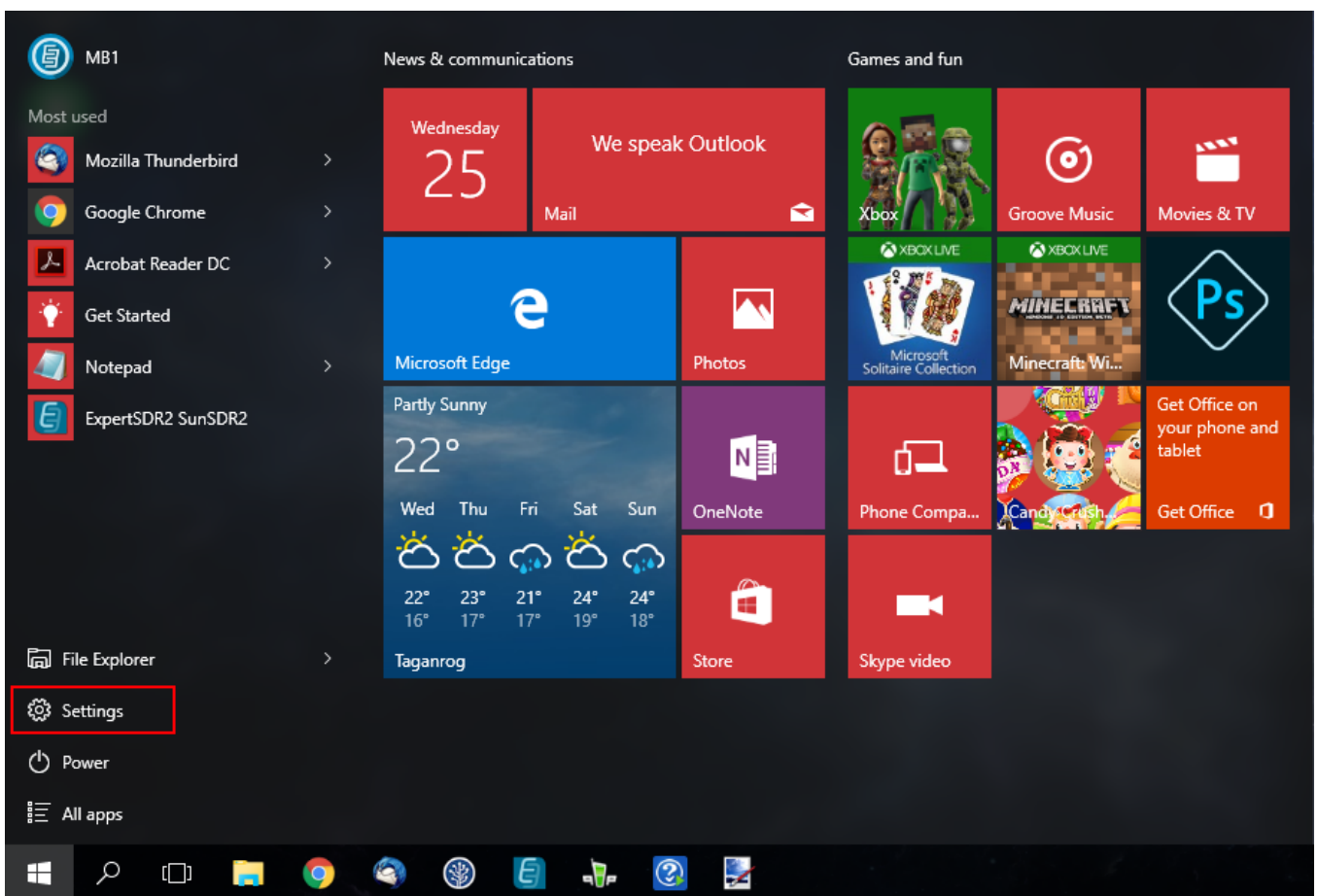

3. In the appeared **Settings** window select the **System** menu by the click of the left mouse button (marked with a red square on the picture below).

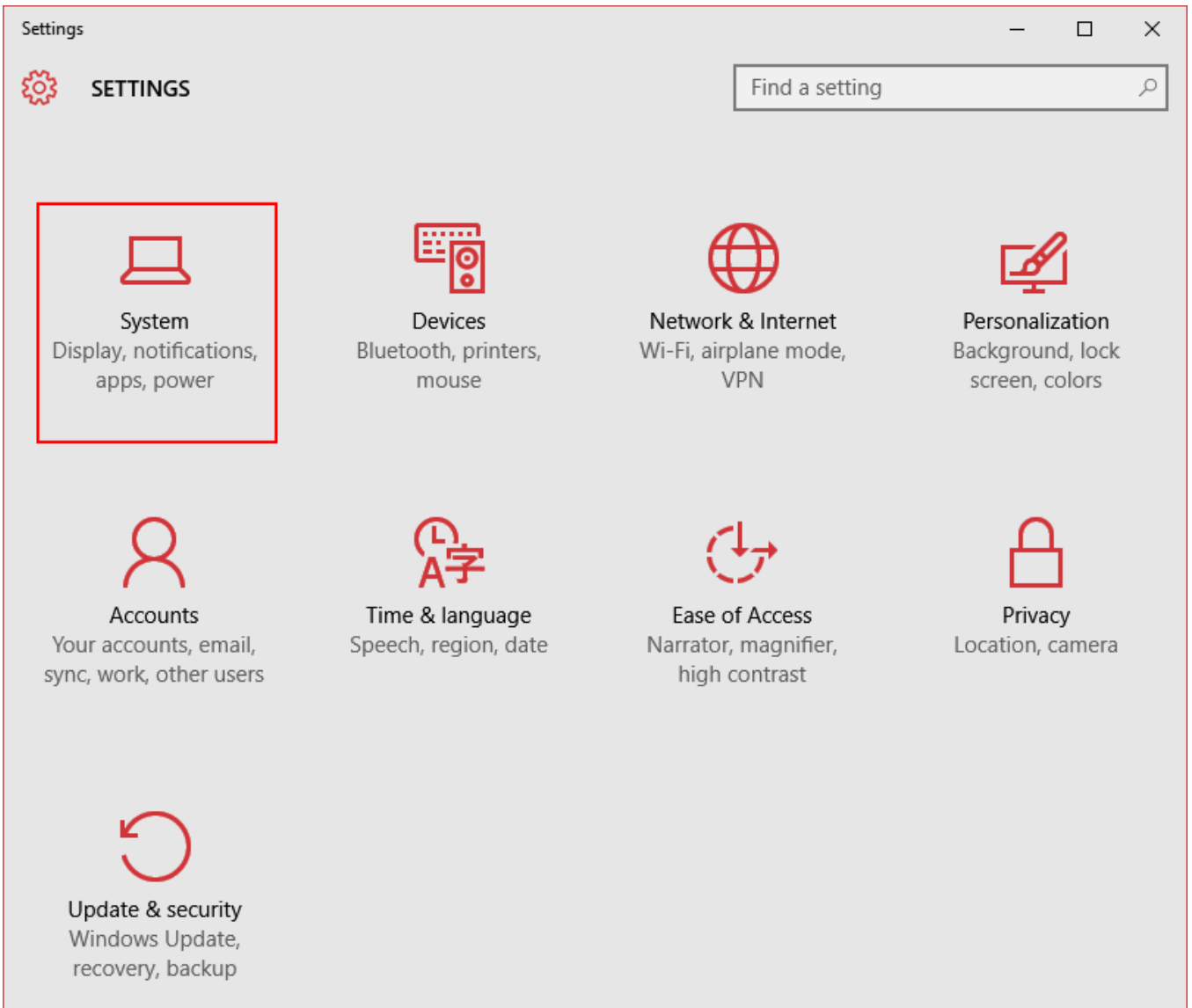

4. In the **System** window select the **About** menu, then select **System info** by the click of the left mouse button (marked with a red rectangle on the picture below).

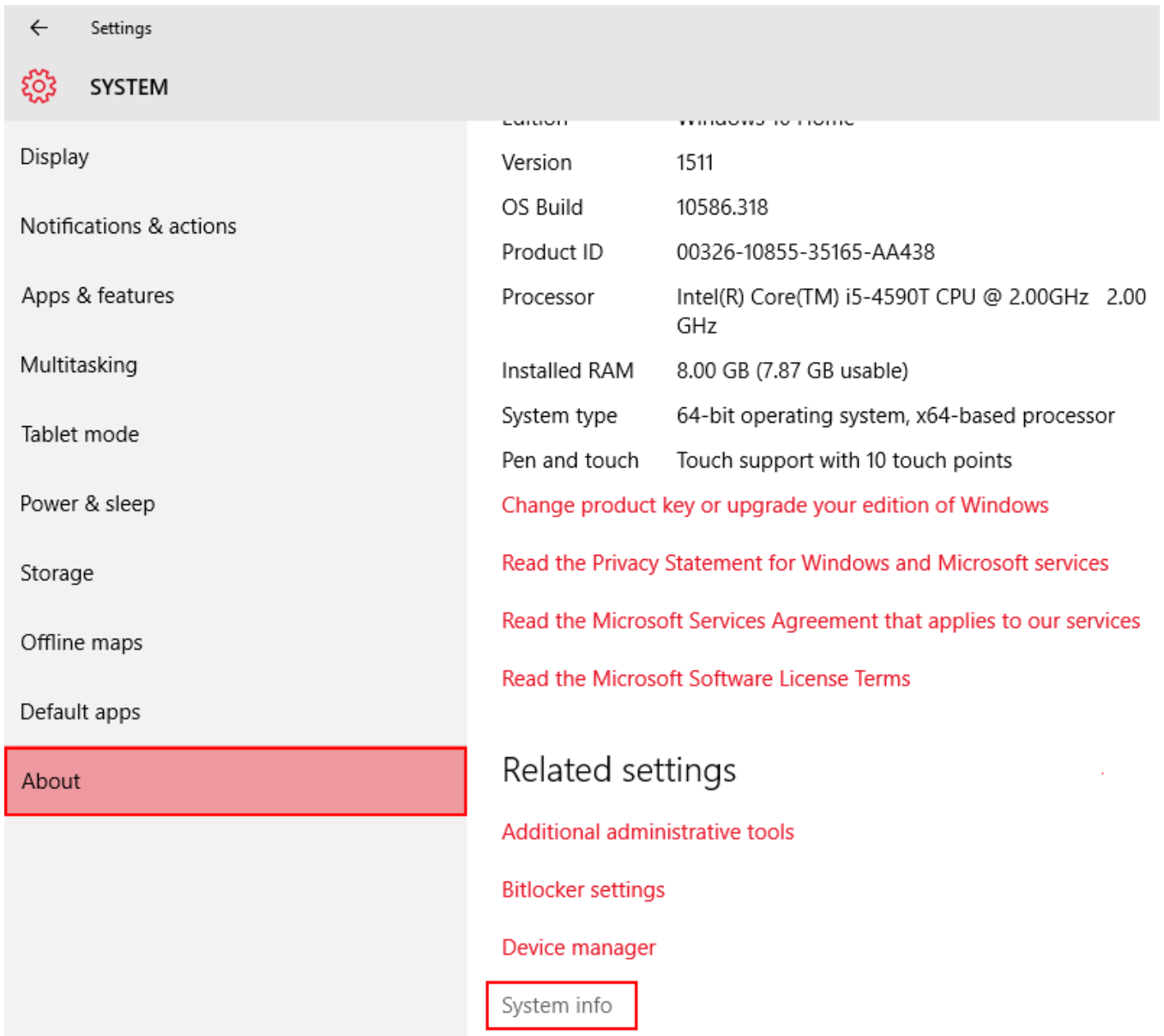

5. In the **System** window select the **Advanced system settings**.

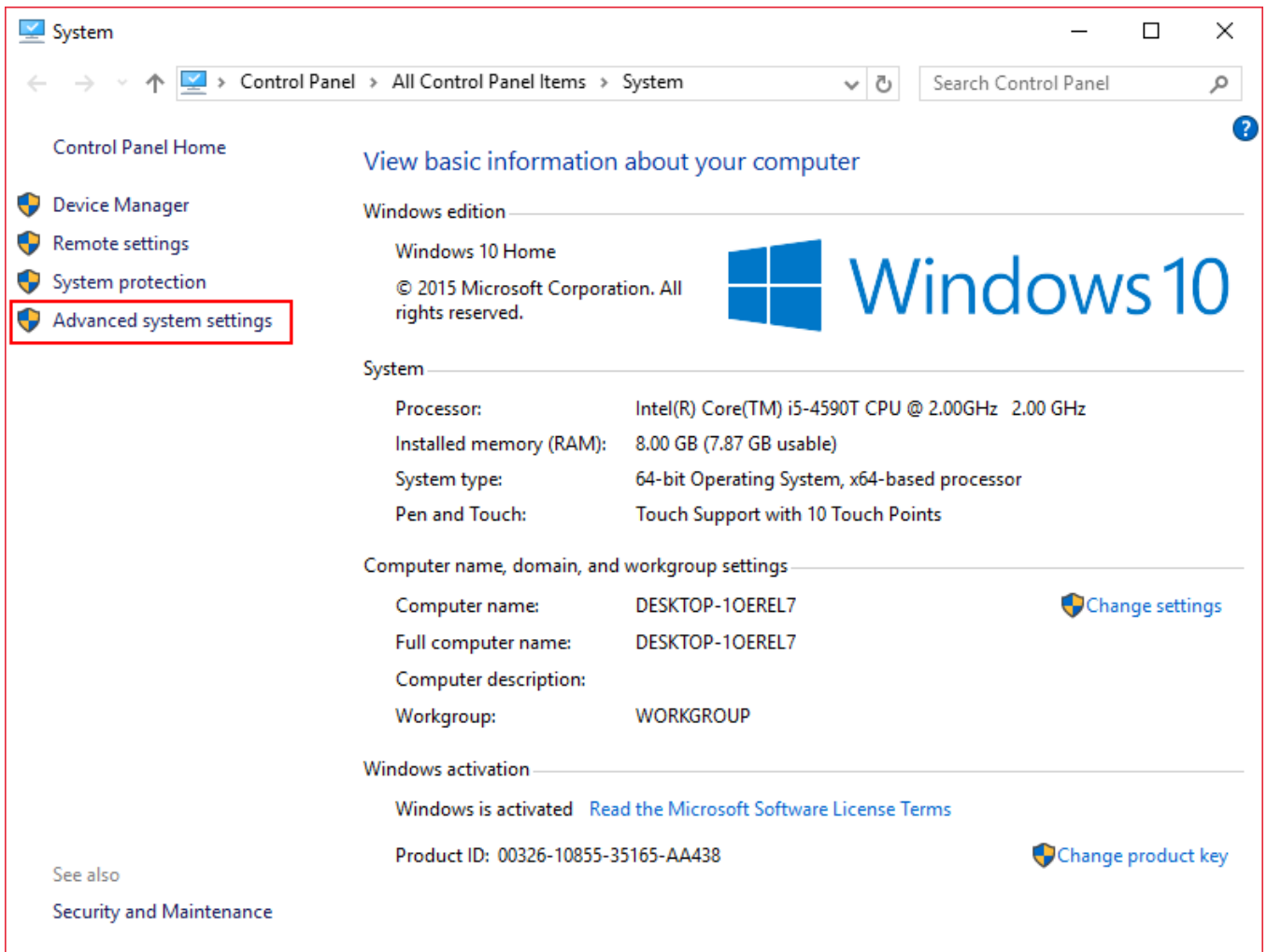

6. In the **System Properties** window select the **System Protection** tab.
7. Select the Local Disk (C:) and press the **Configure** button.

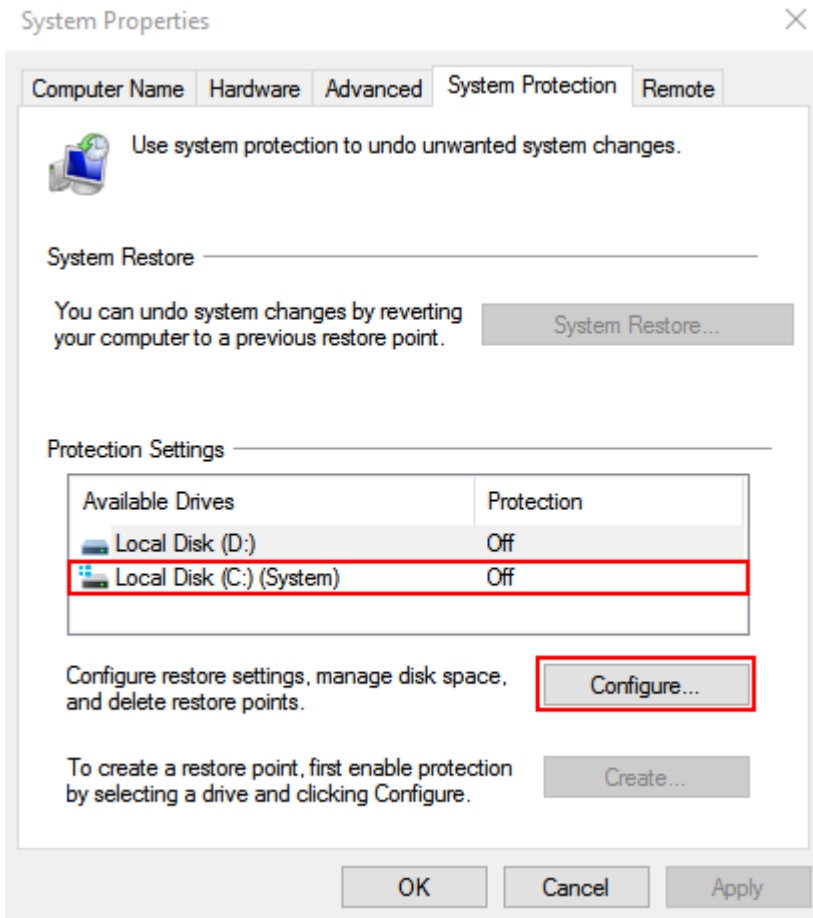

8. In the **System Protection for Local Disk (C:)** window set the **Turn on system protection** and with the slider set the Max Usage for this purposes - it is recommended to use 5...10 % of the disk (see the picture below).
9. Press **Apply** then **OK**, the window will be closed.

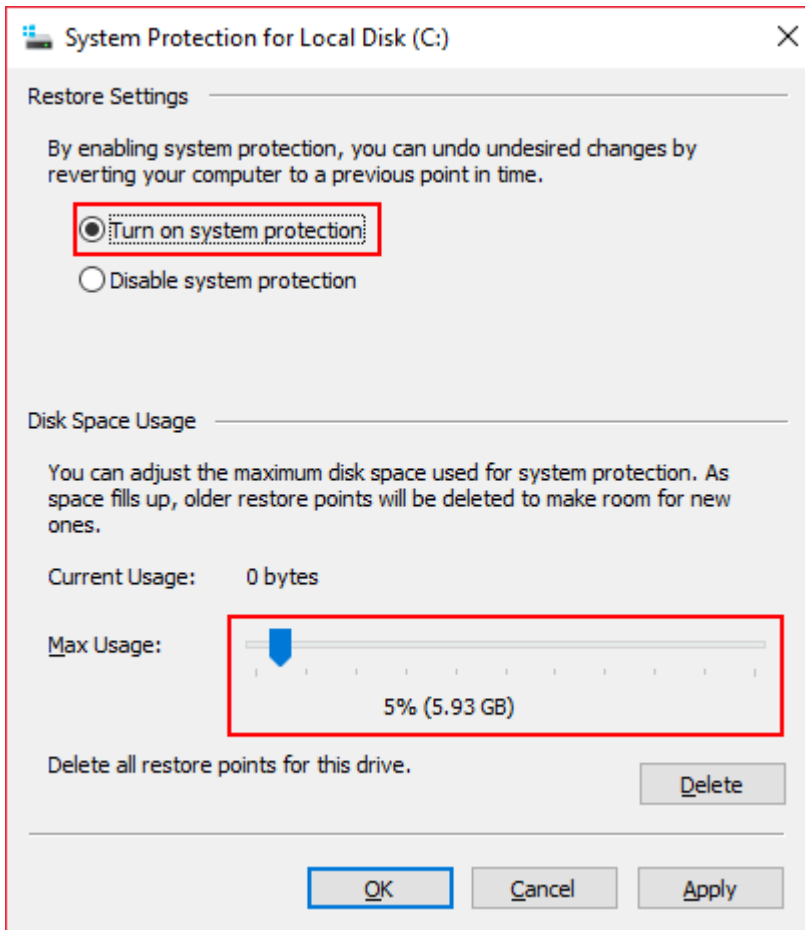

10. In the **System Properties** window press **Create** button (marked with a red rectangle on the picture below).

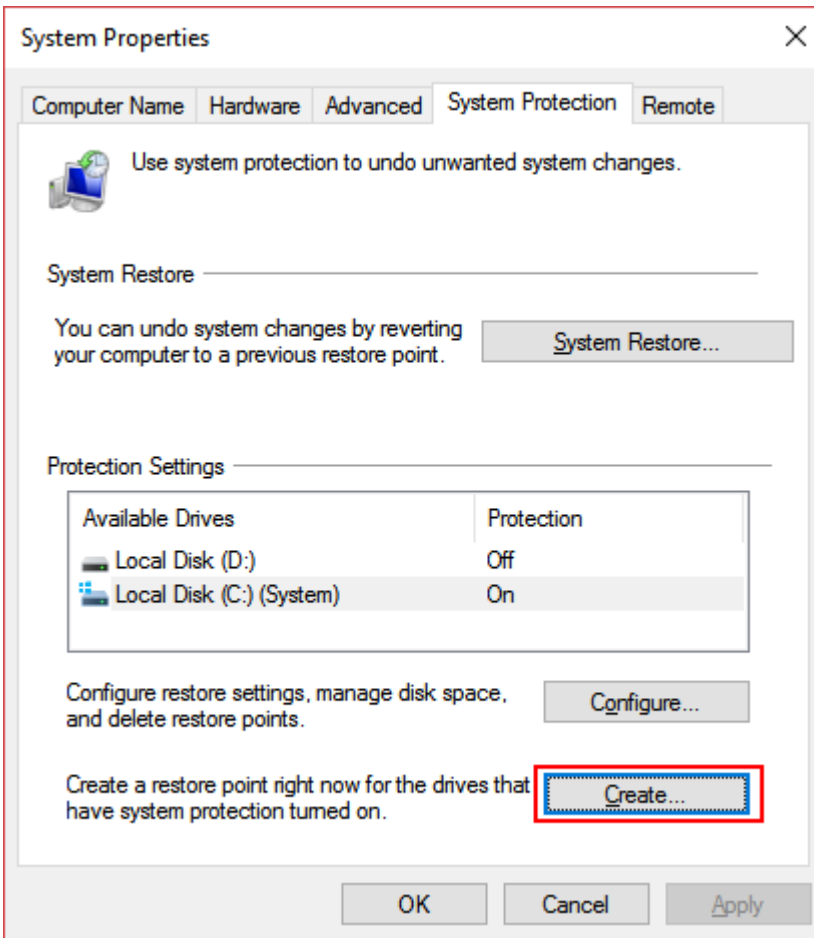

11. In the **System Protection** window enter the name of the restore point, then press the **Create** button.

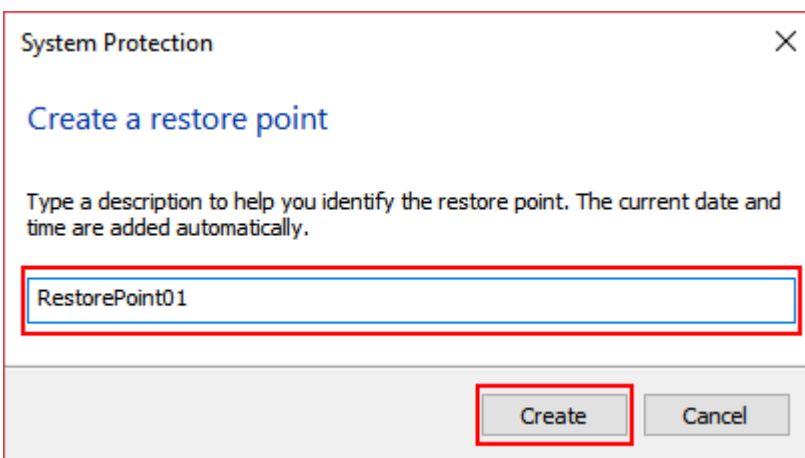

12. **You've created the restore point**, the window will be closed automatically.

5.10.5.2 Use restore point

To **restore the system** from the previously created **restore point** do the following:

1. Open the **Start** menu, by pressing the  in the left bottom corner of the screen.
2. Select **Settings** in the menu (marked with a red rectangle on the picture below).

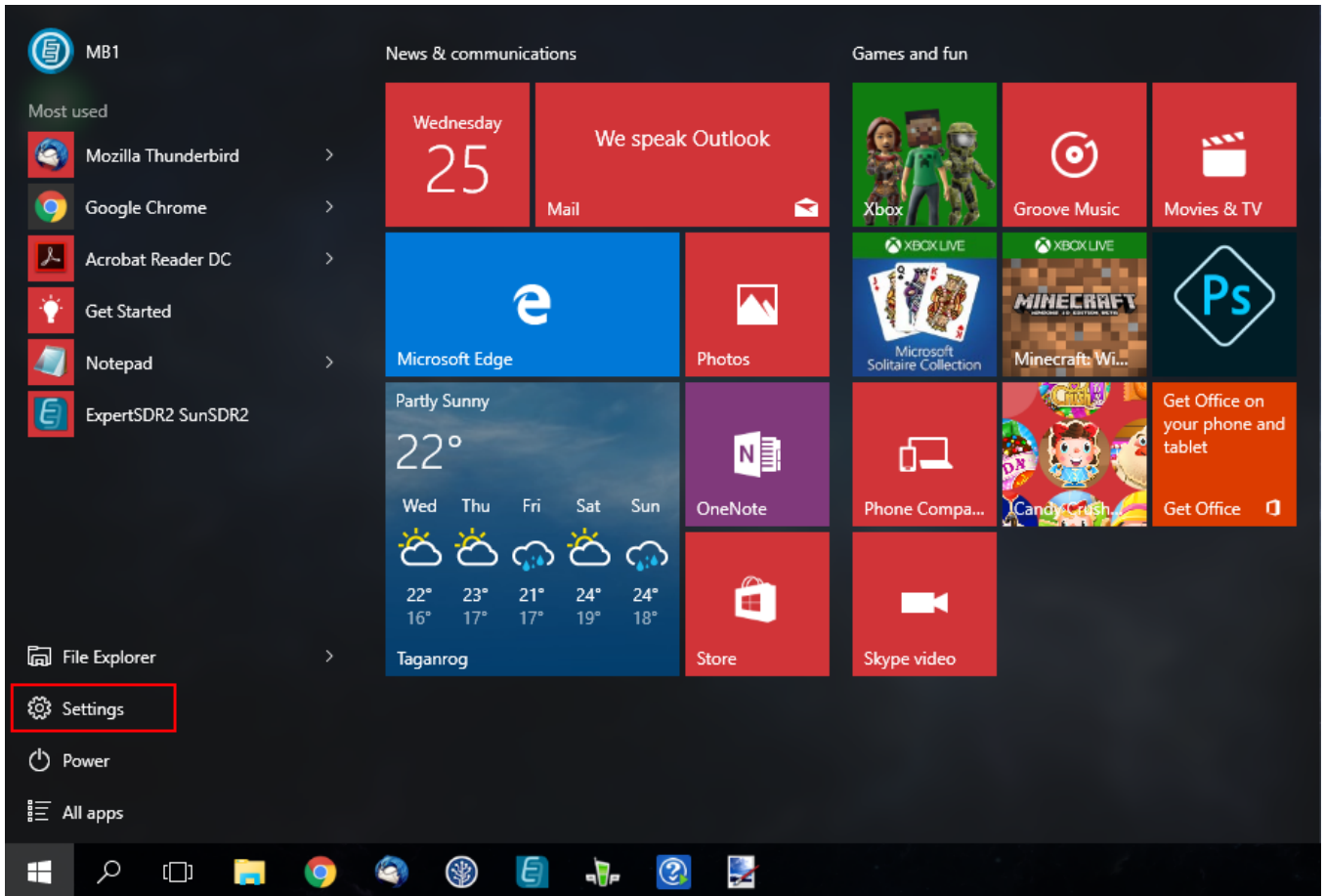

3. In the appeared **Settings** window select the **System** menu by the click of the left mouse button (marked with a red square on the picture below).

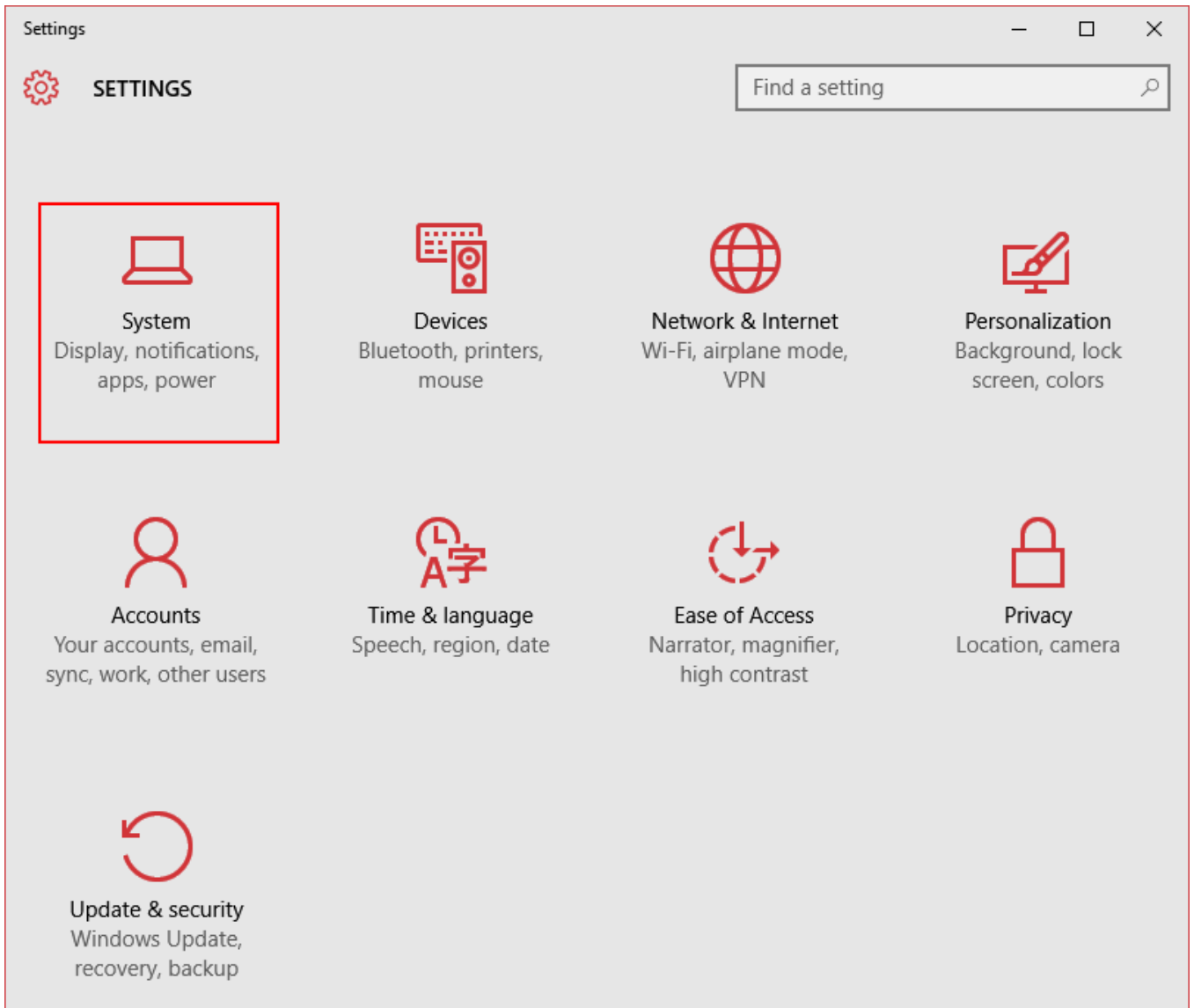

4. In the **System** window select the **About** menu by the click of the left mouse button (marked with a red rectangle on the picture below).

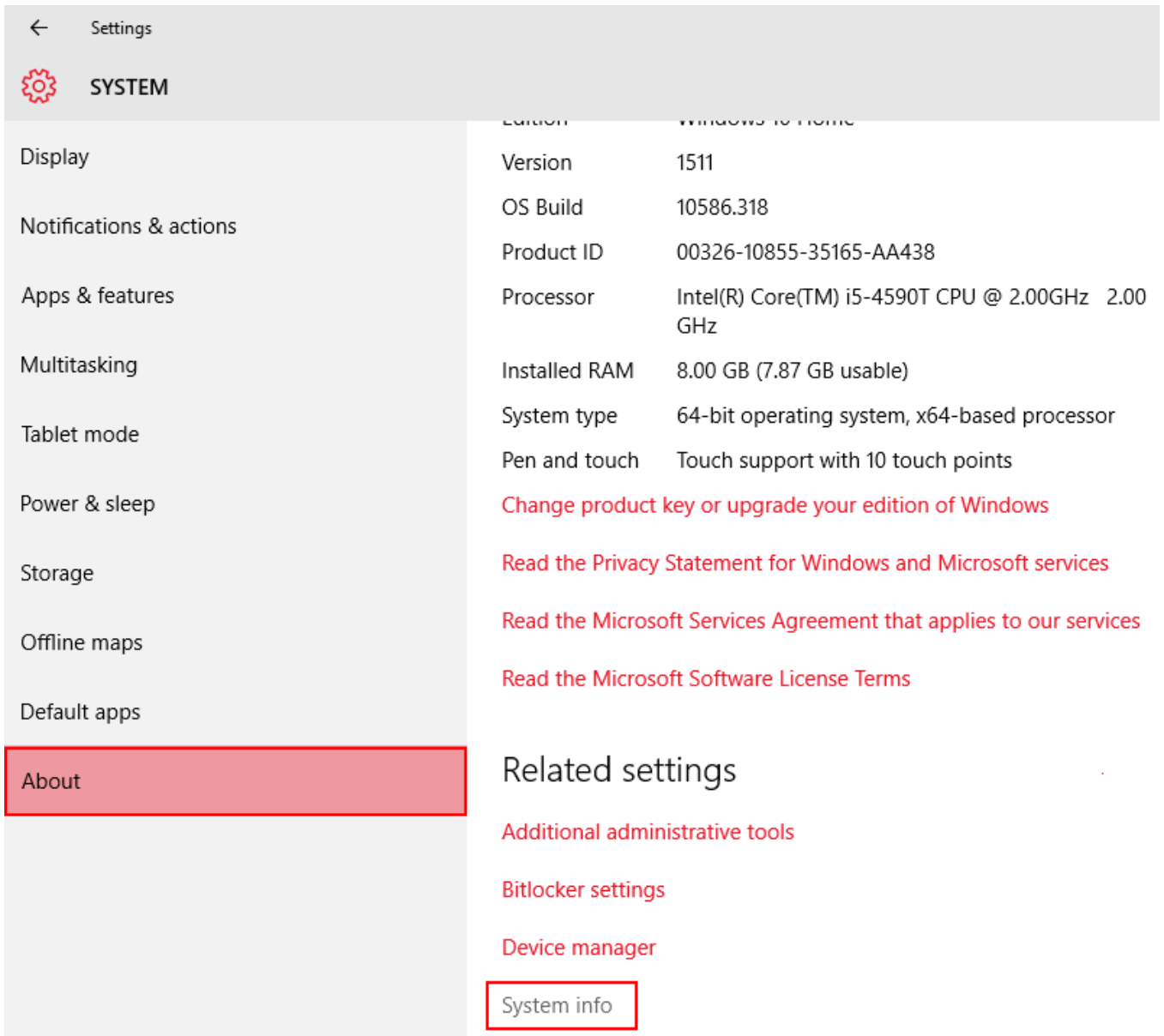

5. In the **System** window select the **Advanced system settings**.

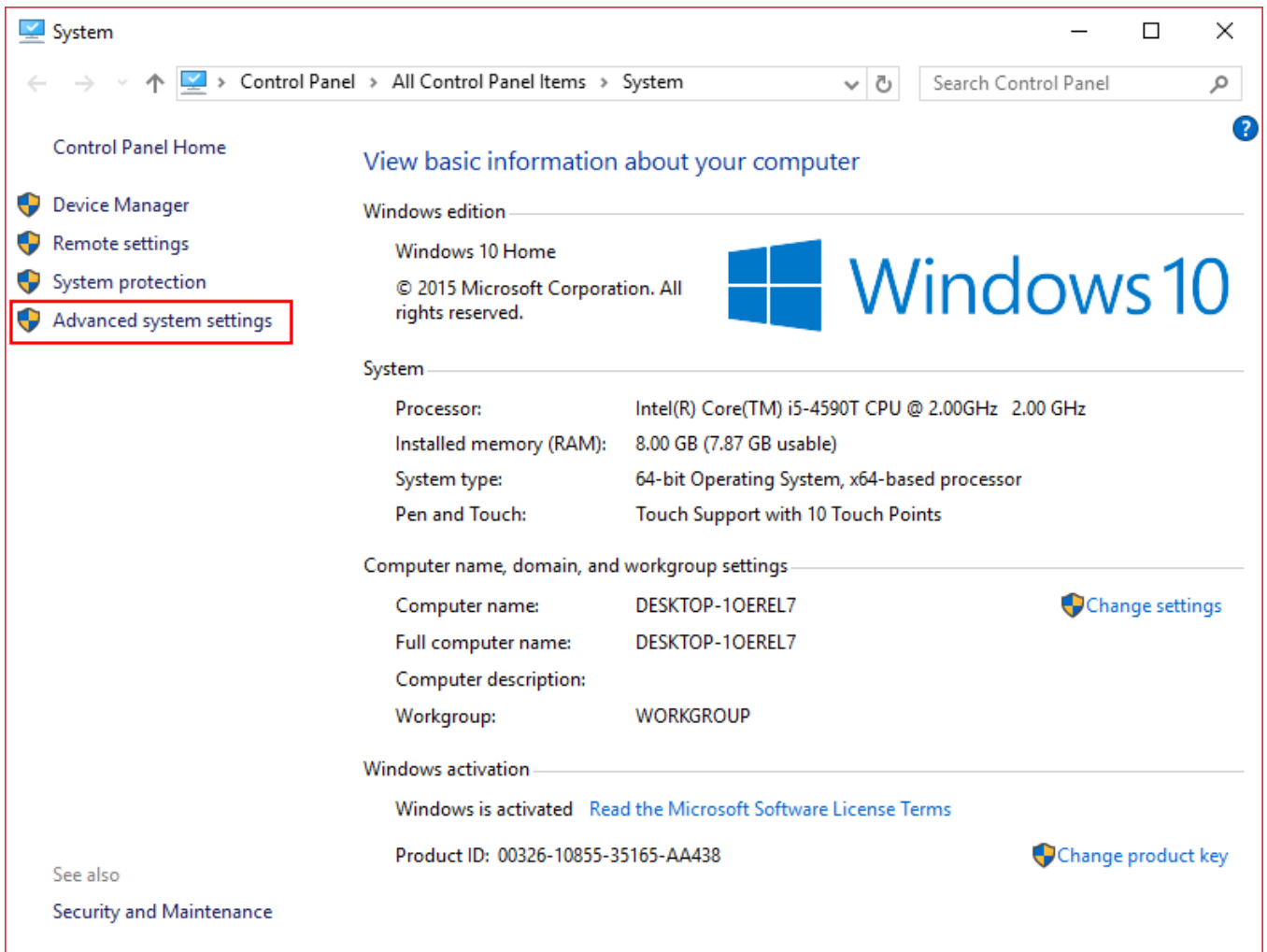

6. In the **System Properties** window select the **System Protection** tab.
7. Press the **System Restore...** button to launch the restore process.

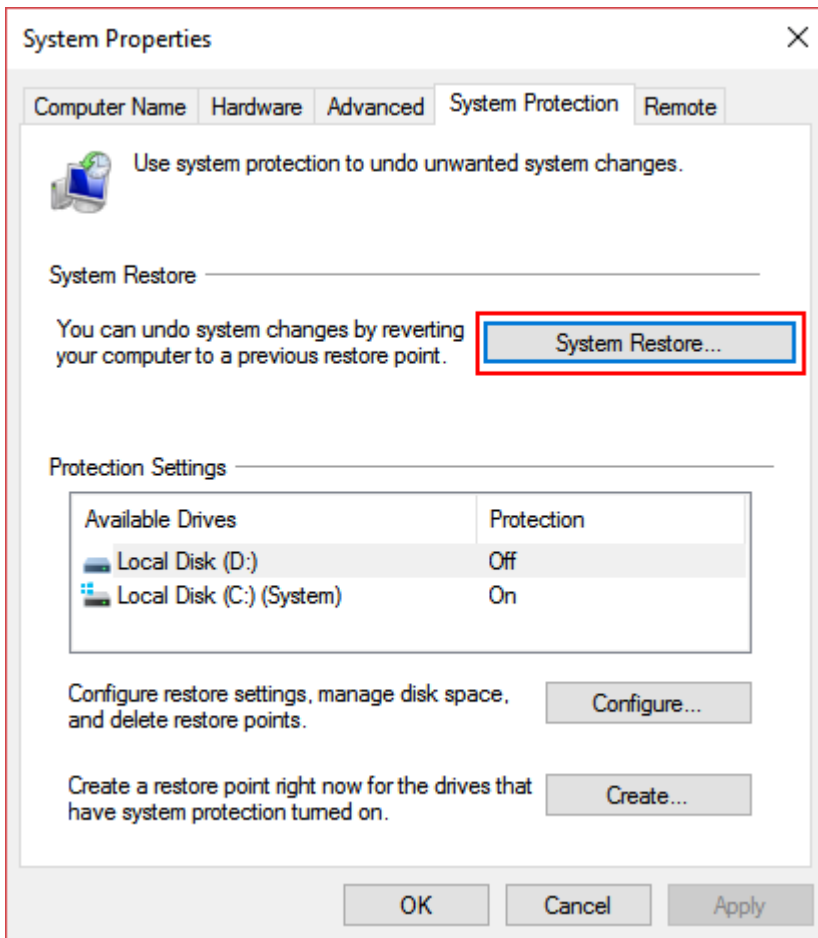

8. In the **System Restore** window press the **Next** button.

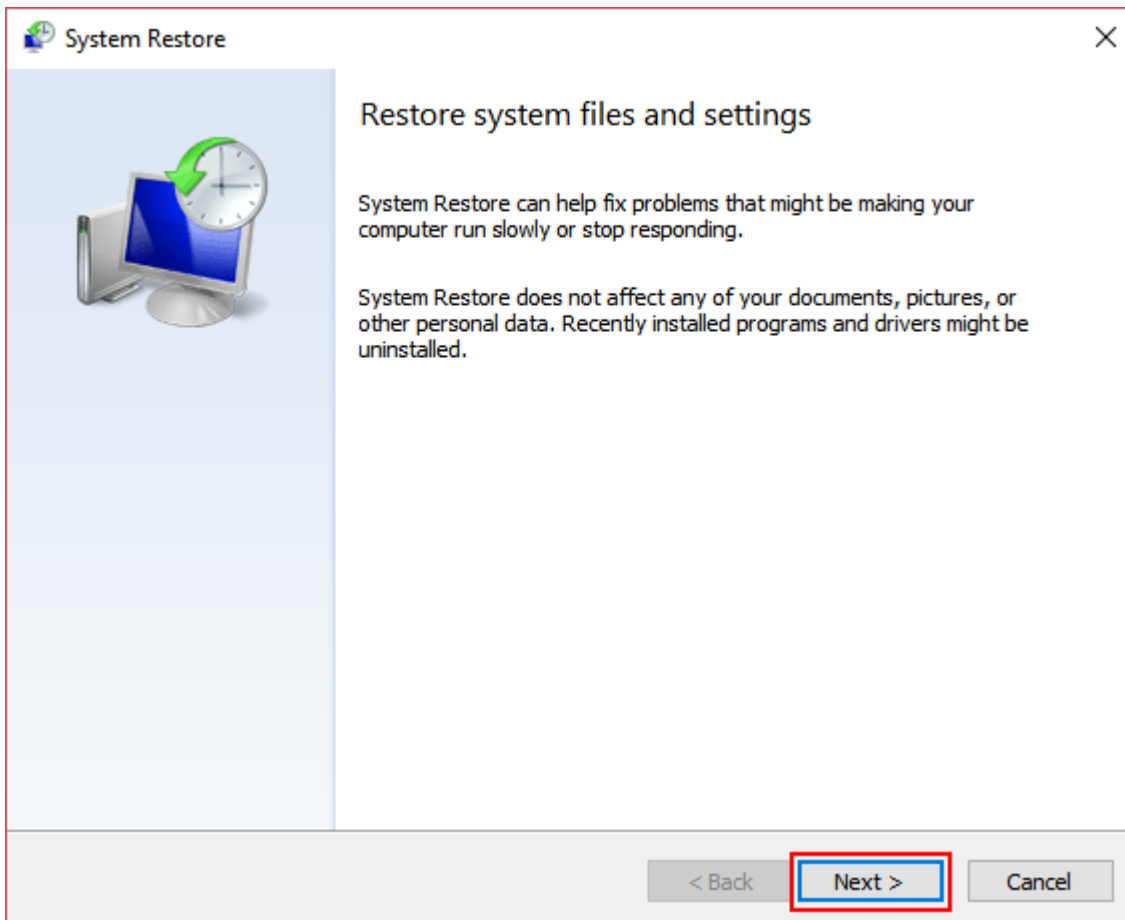

9. On the next step select previously created Restore Point from the list and press the **Next** button.

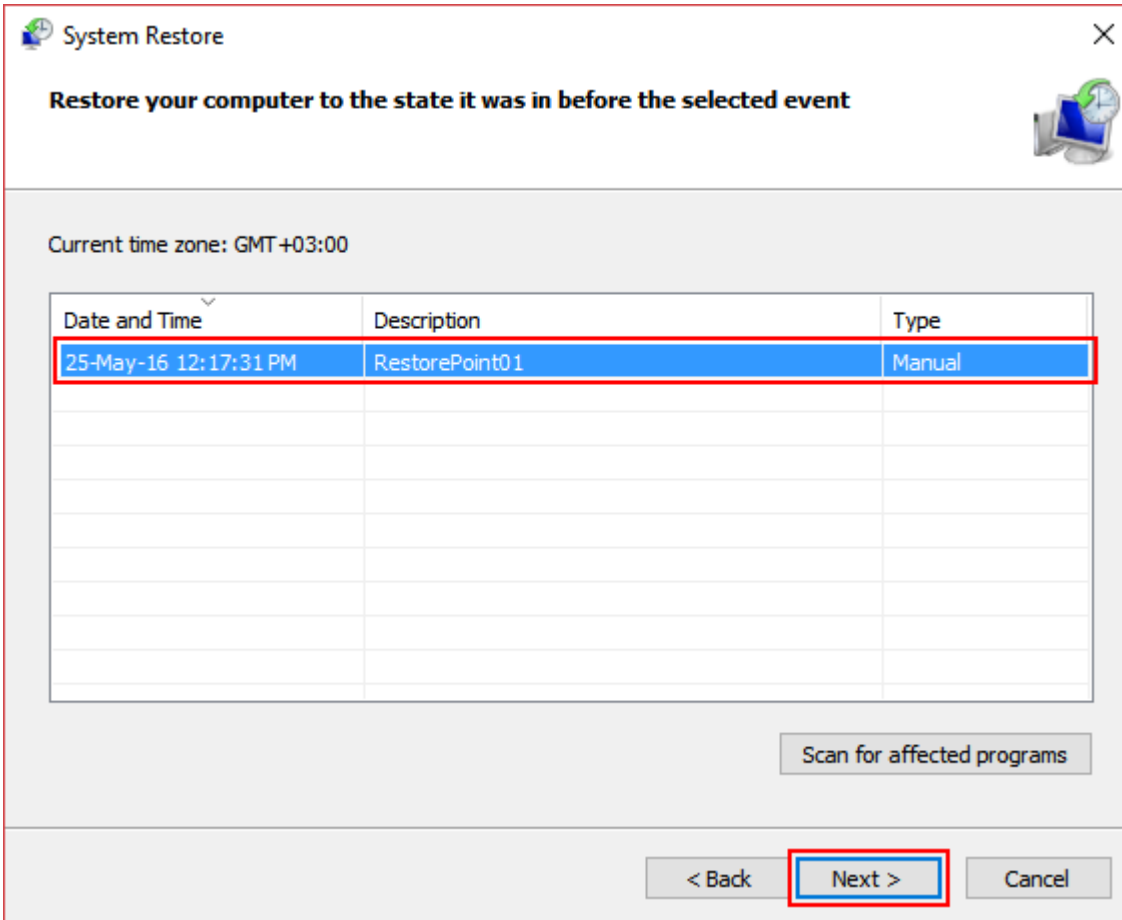

10. Confirm your restore point by pressing the **Finish** button.

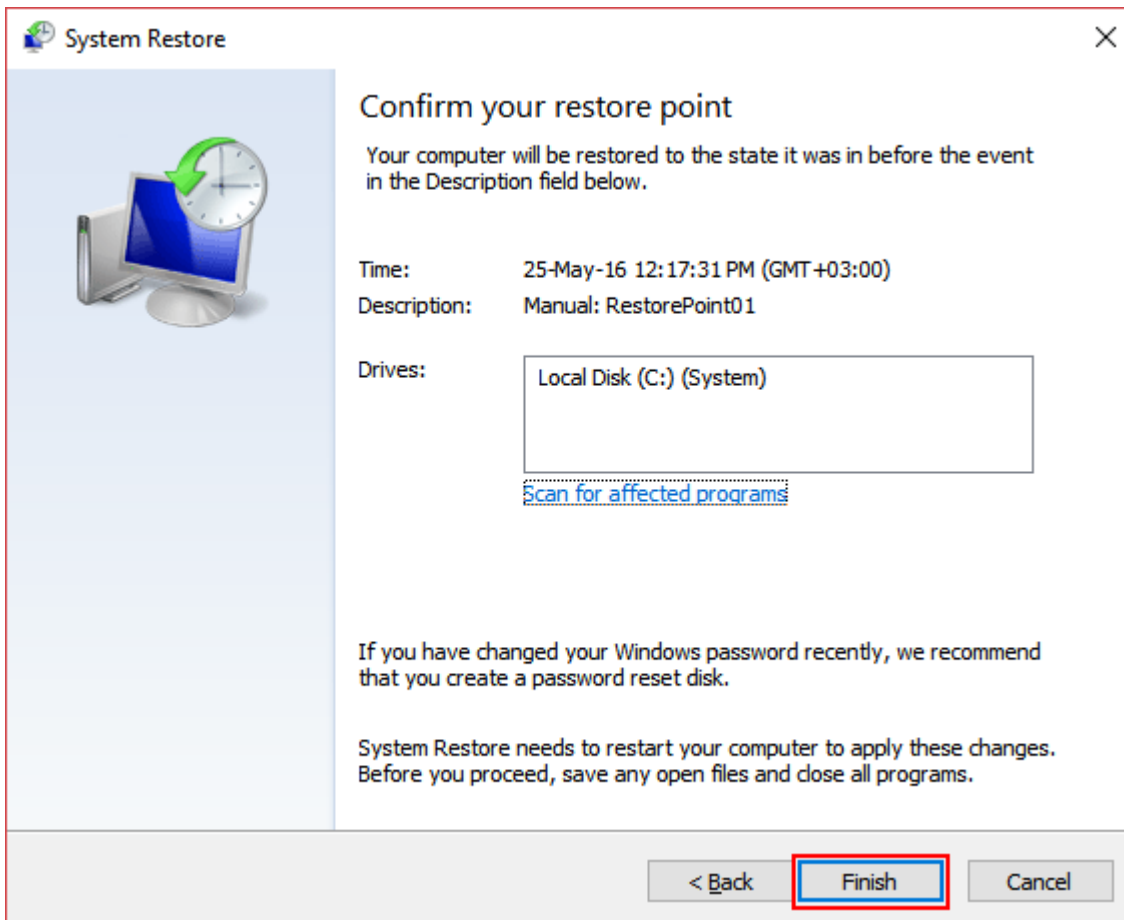

Note:

- ☎ You still can refuse to restore the system on this step, by pressing the **Cancel** button.
- ☎ You still can refuse to restore the system from the selected restore point and change it to another one by pressing the **<Back** button.

11. Windows will inform about successful system recovery. Press the **Close** button.

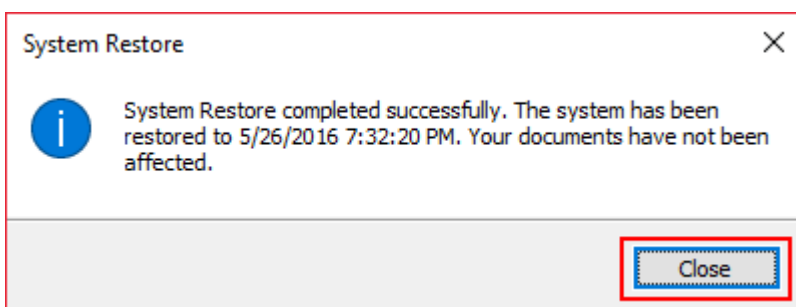

5.10.6 Windows password

For automatic start of the MB1 transceiver by pressing the power button, you need to disable Windows password.

Note:

 Windows password is disabled by default.

5.10.6.1 Enable Windows password

To enable the Windows password for your account, do the following:

1. Click the left/right mouse button on your account name in the **Start** menu and select **Change account settings**.

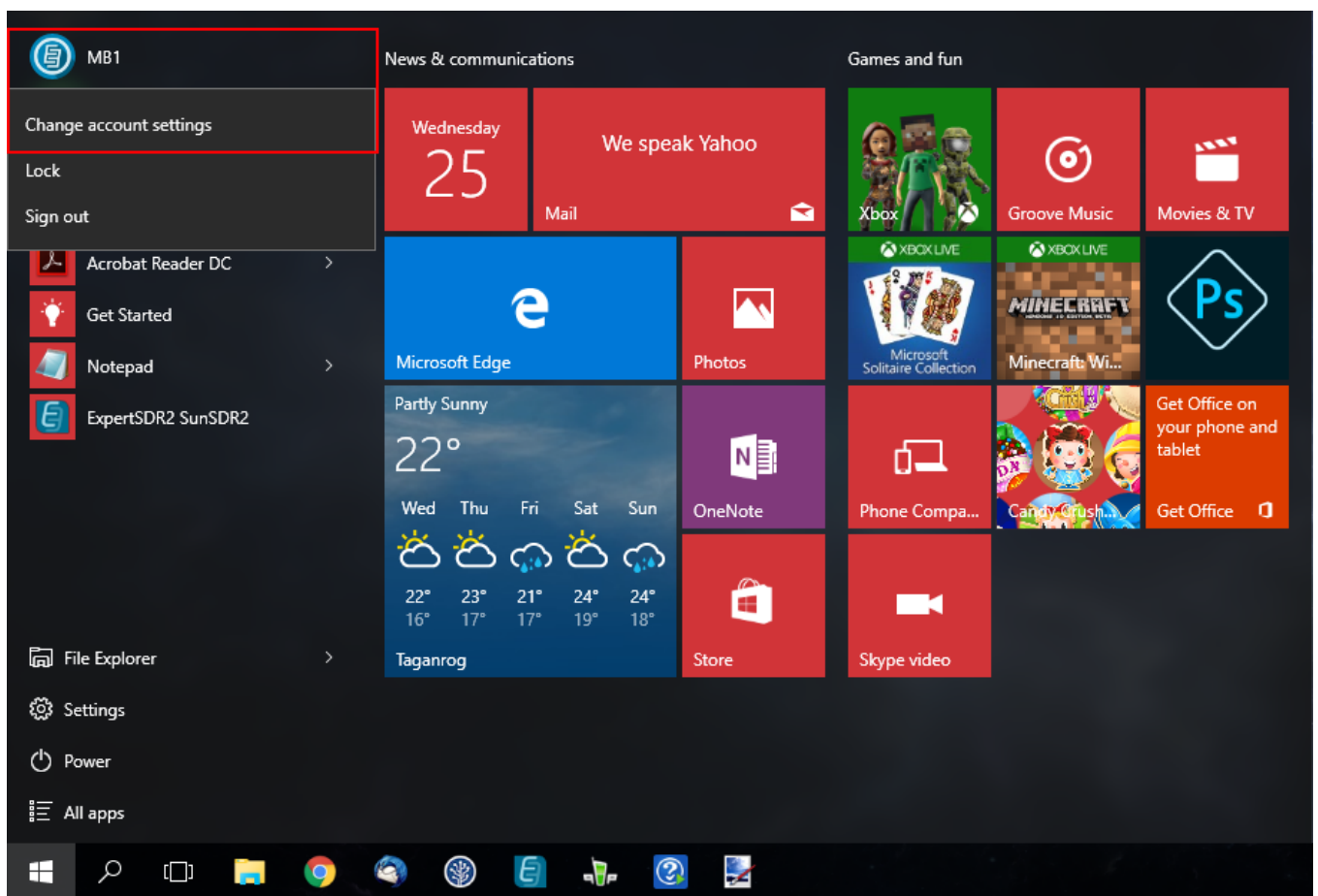

2. In the **Accounts** window select **Sign-in options** menu.
3. In the **Require sign-in** drop-down menu, in case you are absent for a while, select **Never**.

Press the **Add** button and follow the instructions.

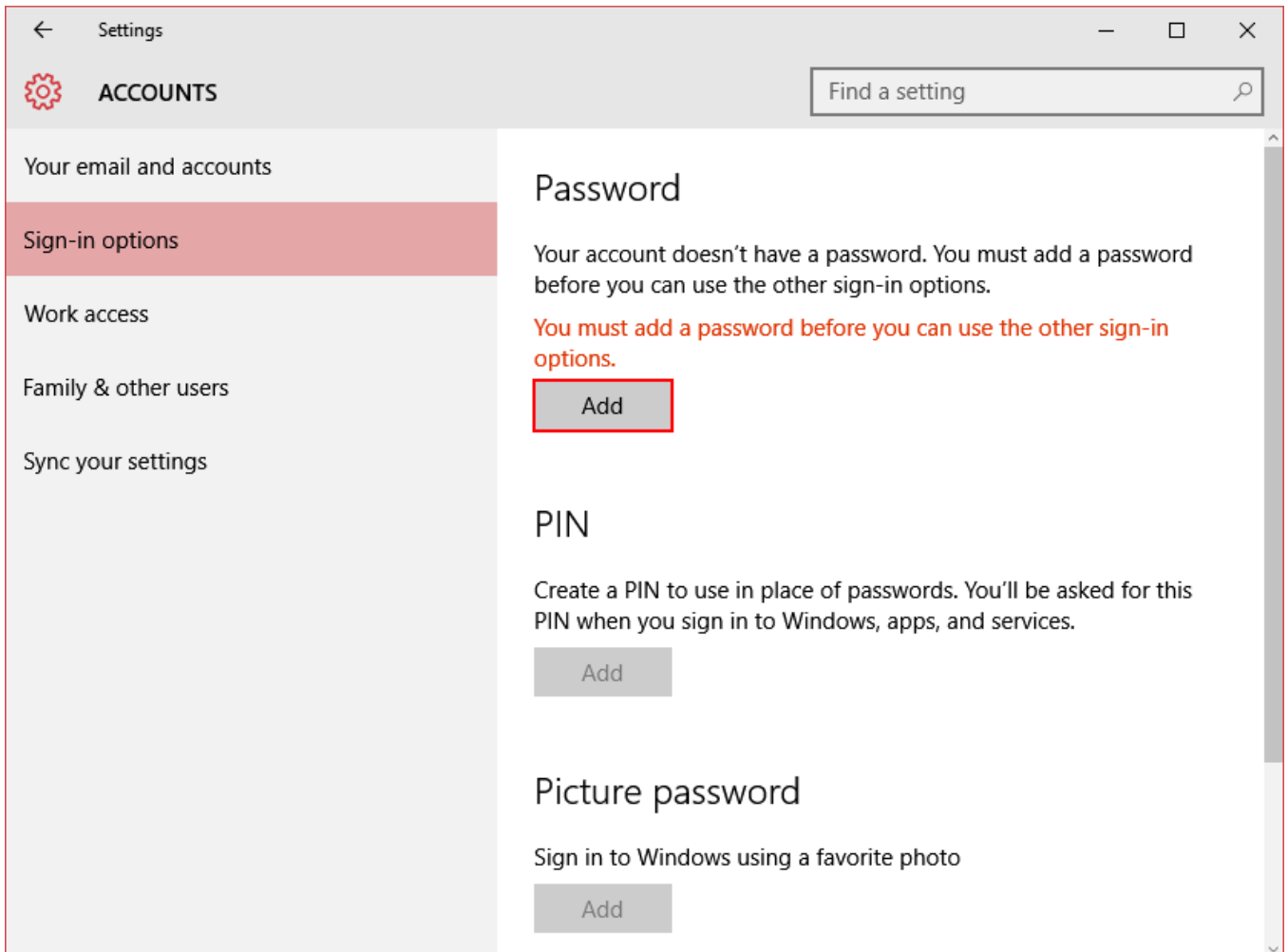

Note:

 *Now Windows will require the password each time you launch the transceiver.*

5.10.6.2 Disable Windows password

To disable the Windows password for your account, do the following:

1. Click the left/right mouse button on your account name in the **Start** menu and select **Change account settings**.

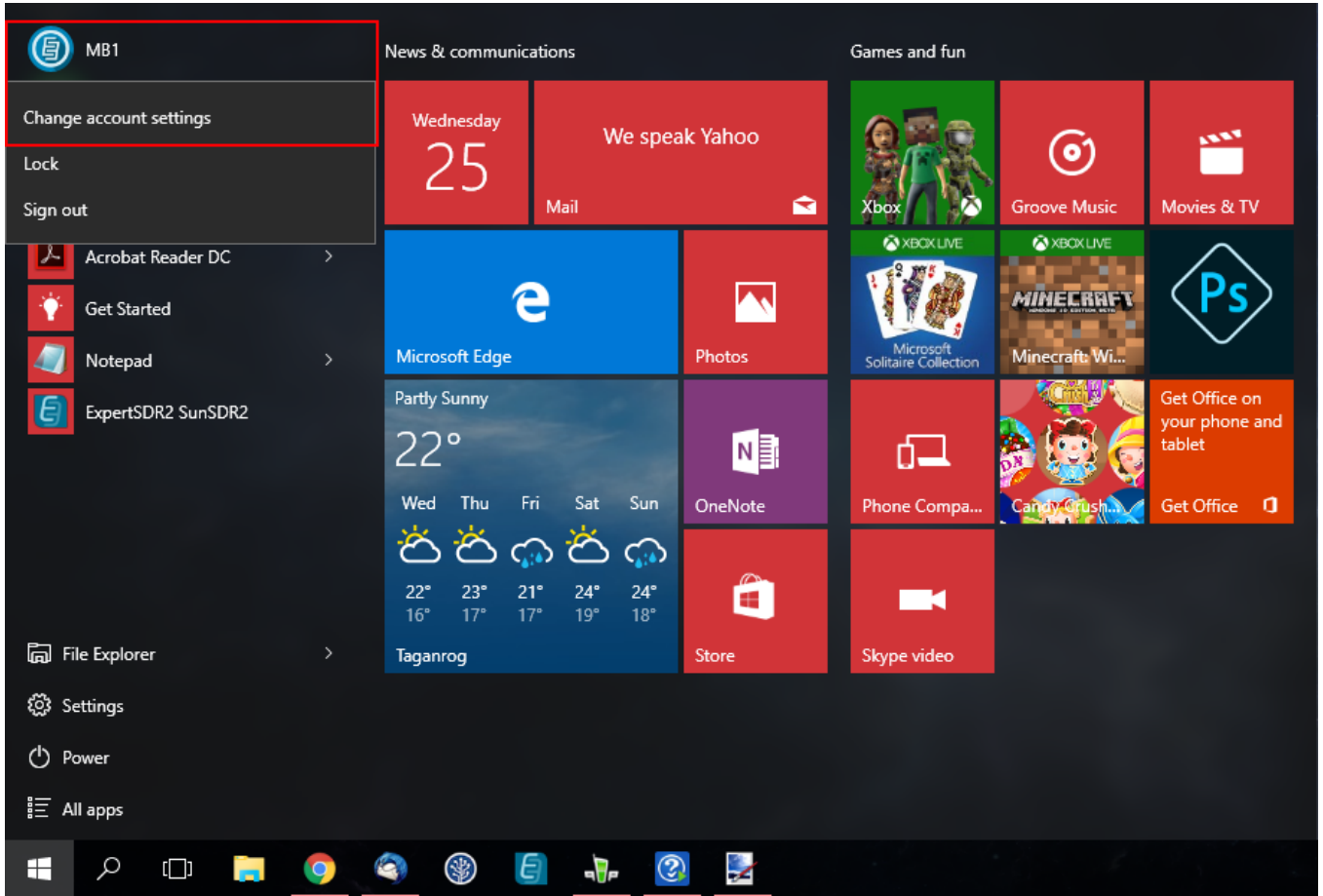

2. In the **Accounts** window select **Sign-in options** menu.
3. In the **Require sign-in** drop-down menu, in case you are absent for a while, select **Never**.
4. Press the **Change** button.

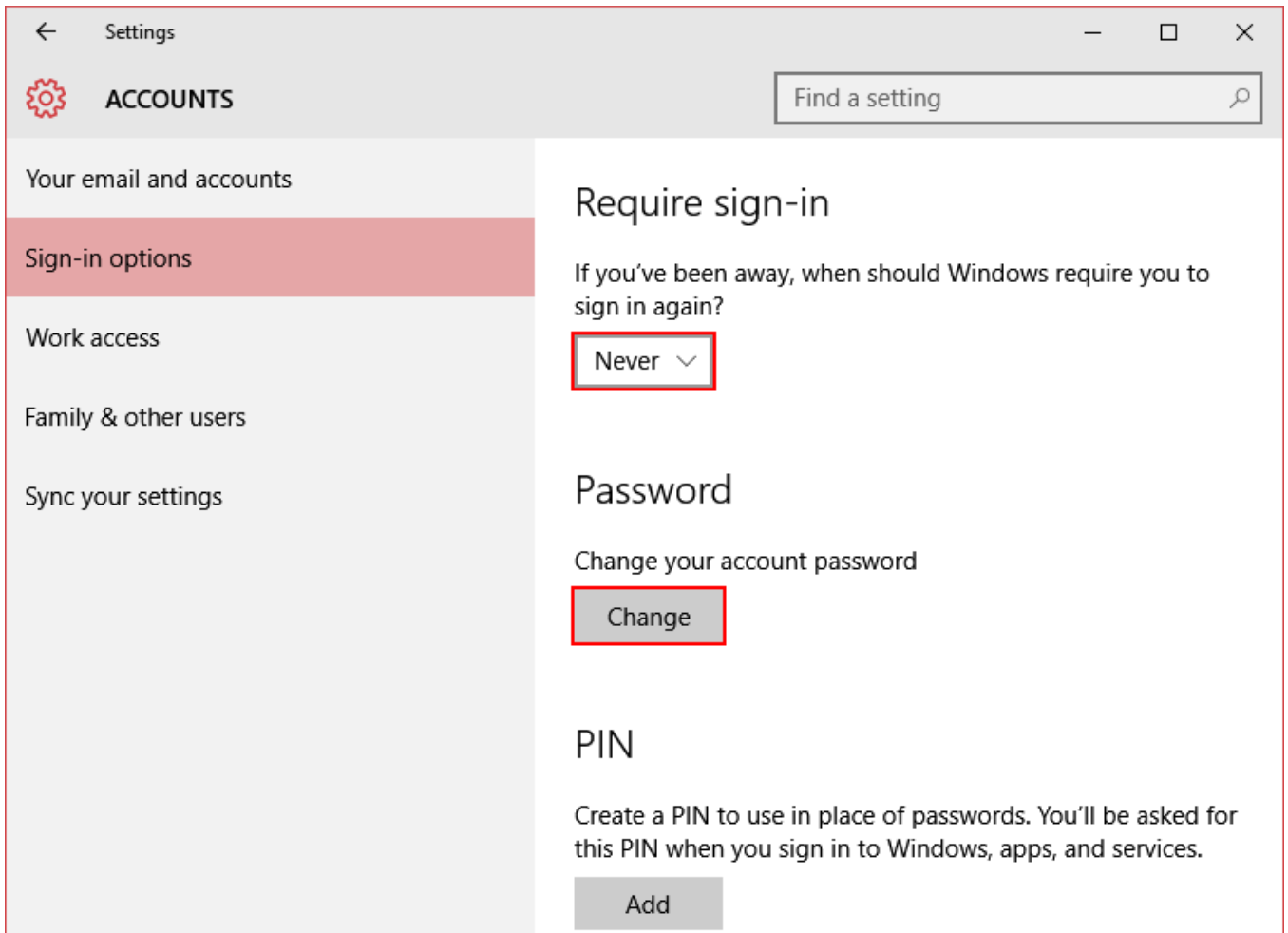

5. In the **Change your password** window enter your current password and press the **Next** button.

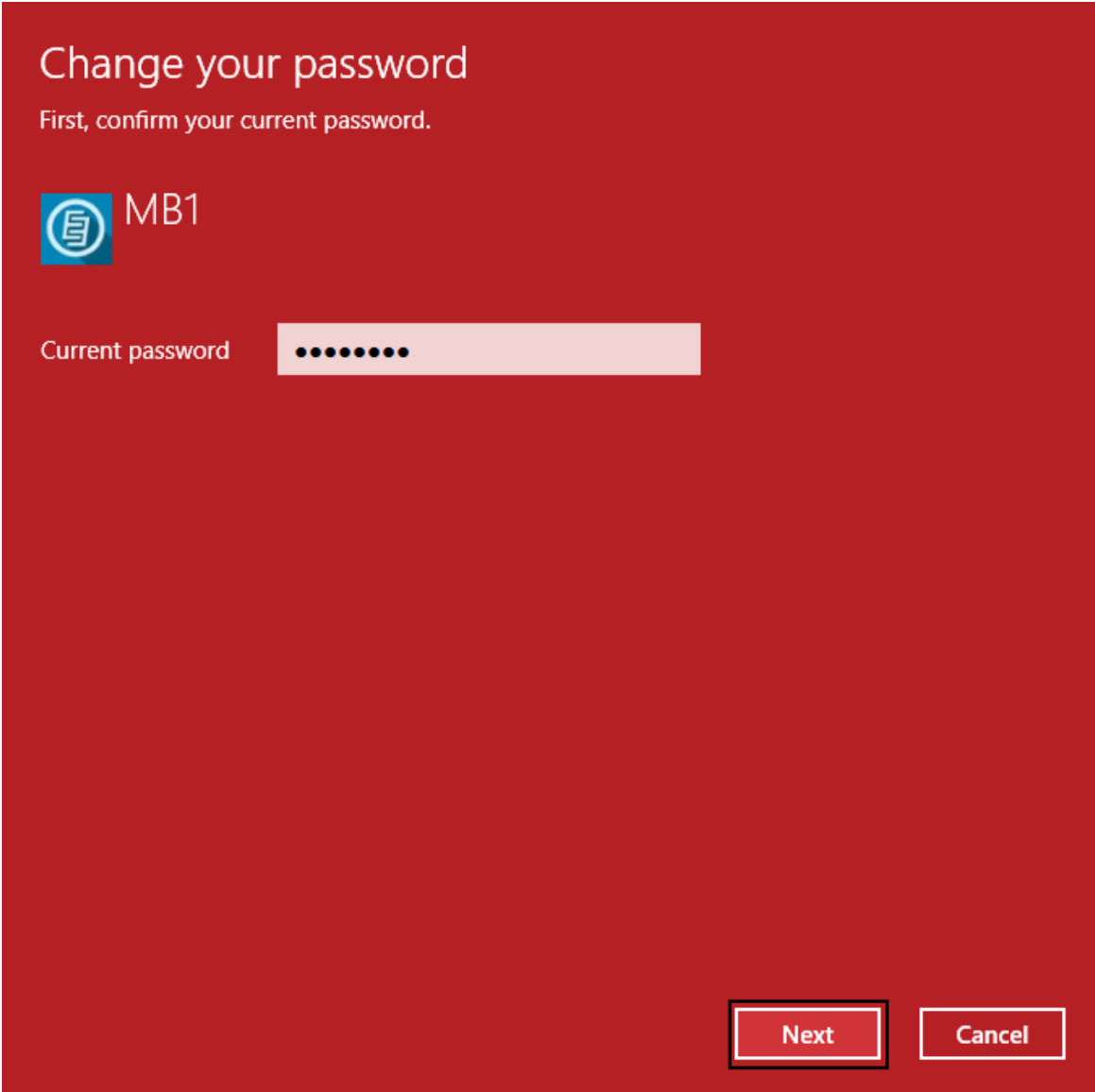

Change your password

First, confirm your current password.

 MB1

Current password

6. In the next **Change your password** window left **New password** and **Reenter password** fields blank, press the **Next** button, the window will be closed automatically.

Change your password

New password

Reenter password

Password hint

Next Cancel

7. Close the **Accounts** window.

Note:

 Now Windows will **not** require the password each time you launch the transceiver.

6 TECHNICAL CHARACTERISTICS

6.1 Receiver

Characteristic	Value
Design concept of the receive path	Direct Digital Conversion
RF ADC clock frequency, MHz	160
RF ADC resolution, bit	16
RX frequency range, MHz	0,09 ... 65; 95 ... 148
The maximum width of the spectrum display, MHz	80
Amount of independent RX channels	2
Blocking Dynamic Range (BDR), dB	129...130
Dynamic Range over IMD3, dB	98
MDS level, dBm	-124
Image channel rejection, dB	> 110
Local oscillator stability, ppm	+/- 0.5
Additional VHF preamplifier, dB	+22

6.2 Transmitter

Characteristic	Value
The method of signal generation	Digital Up Conversion
RF DAC clock frequency, MHz	640
RF DAC resolution, bit	14
The range of transmission frequencies, m	160, 80, 40, 30, 20, 17, 15, 12, 10, 6, 2
Maximum output power in HF, W	100
Maximum output power in VHF, W	50
ATU matching band, Ohm	15-20...300-500

6.3 Internal PC

Characteristic	Value
Motherboard	Form factor thin Mini-ITX, Gigabyte
Processor	Intel Core i5 quad-core 3.0 GHz
RAM	8GB
Hard drive	SSD, 128GB
USB-ports	4x USB 3.0 on the transceiver's rear panel 2x USB 2.0 on the transceiver's front panel
Ports for external monitors	HDMI and DPORT
Network port	LAN 1Gb
Other	COM-port

6.4 Other

Characteristic	Value
Dimensions, mm	320x140x250
Weight, kg	10
Power voltage range, V, Hz	~100 ... 240, 50-60
Maximum power consumption, W	320
Operating temperature, °C	0... +50

7 TRANSCEIVER OPERATIONS

In this chapter you will find all basic transceiver operations.

7.1 Turning ON/OFF the transceiver

Before turning on the device, make sure that the power cable is connected to the AC mains and the switch on the rear panel of the transceiver is in the "I" position.

To **turn on** the transceiver, short press the power button - 

A short beep will inform that the transceiver is switched On.

The transceiver will start in approximately 30 seconds and will begin to work in normal mode.

To turn off the transceiver, press and hold the power button for about 1 second - 

A short beep will inform you that the switch off process is initialized and you can release the power button.

The transceiver will turn off in approximately 5 seconds.

Note:

← If for some reason the Windows OS "freezes" and you cannot shut down the transceiver in the normal way, you should use the following algorithm to force a shutdown of the transceiver.

← To force the shutdown of the transceiver press and hold the power button for about 5 seconds - 

Warning!

This applies only for the transceivers from the first and the second batches.

① We recommend to turn off the transceiver only with the  button, on the front panel of the transceiver.

① Turn off the transceiver, by turning off Windows in the Start menu, may lead to malfunctions.

7.2 Frequency Tuning

Frequency tuning could be performed via several means:

Rotate the **DRIVE** knob clockwise to increase output power, counter clockwise to decrease output power

- **Rotating the Main Knob.**

Rotate the knob clockwise to increase the tuning frequency.

Rotate the knob counter clockwise to decrease the tuning frequency.

Note:

☎ When the **D/I** function is **enabled** tuning frequency is carried out by moving the receiver filter over the spectrum scope (stations hold their positions).

When the **D/I** function is **disabled** (by default) tuning frequency is carried out by moving the spectrum scope (filter holds its position).

- **Rotating the MULTI 3 knob.**

Rotate the knob clockwise to increase the tuning frequency.

Rotate the knob counter clockwise to decrease the tuning frequency.

Note:

☎ The **Main Knob** controls the tuning frequency of the **VFO A** of the RX1 receiver.

The **MULTI 3** knob controls the tuning frequency of the **VFO B** of the RX1 receiver.

☎ In the **A/B** mode the **Main Knob** controls the tuning frequency of the **VFO B** of the RX1 receiver.

The **MULTI 3** knob controls the tuning frequency of the **VFO A** of the RX1 receiver.

☎ In the **RX2** mode (more details in [Front Panel Description, paragraph 21^{D31}](#)) the **Main Knob** controls the tuning frequency of the **VFO A** of the RX2 receiver.

The **MULTI 3** knob controls the tuning frequency of the **VFO B** of the RX2 receiver.

☎ In the **RX2** mode, **A/B** mode the **Main Knob** controls the tuning frequency of the **VFO B** of the RX2 receiver.

The **MULTI 3** knob controls the tuning frequency of the **VFO A** of the RX2 receiver.

- **Rotating the mouse wheel.**

Rollover mouse cursor on any place on the spectrum scope or waterfall and rotate the mouse wheel forward - receivers tuning frequency will be increased with the current **STEP** value.

Rollover mouse cursor on any place on the spectrum scope or waterfall and rotate the mouse wheel backward - receivers tuning frequency will be decreased with the current **STEP** value.

- **Fast tuning by the mouse click.**

Rollover mouse cursor on the required place on the spectrum scope or waterfall and click the left mouse button - receiver's filter will move to this location.

Note:

 If the **Sub-receiver** or the **SPLIT** mode is enabled, then for the **Fast tuning by the mouse click** between **VFO A** and **VFO B** press the **mouse wheel** on the spectrum scope or waterfall. While tuning, color of the mouse cursor will match the controlled receiver - color of the mouse cursor also match the receiver's tuning line.

 **Fast tuning by the mouse click** tuning mode is convenient in combination with the **Rotating the mouse wheel** mode. Mouse click on the station's signal and perform fine tuning with the wheel if you slightly missed.

- **Moving the receiver's filter** over the spectrum scope.

Place the mouse cursor approximately in the middle of the receiver's filter, press the **left** mouse button and while holding it drag the receiver's filter - it will follow the mouse cursor over the spectrum scope. Release the left mouse button when the signal match the filter position - receiver's filter will hold its position after you release the button.

- **Moving the Spectrum Scope** (*filter holds its position*).

Press the right mouse button on any place over the spectrum scope or waterfall and while holding it drag the spectrum scope until the required frequency match the filter position. Tuning is carried out with the current **STEP** value.

- **Moving the receiver's filter with the Spectrum Scope** (tuning frequency won't change).

Place the mouse cursor approximately in the middle of the receiver's filter, press the **right** mouse button and while holding it drag the receiver's filter - it will follow the mouse cursor over the panorama along with the spectrum scope. Release the button to stop tuning.

Note:

 Basically it is not tuning, but it allows you to look at the air beyond the panorama window, without detuning the receiver.

- **Mouse click on the digit position of the frequency indicator.**

Rollover mouse cursor on the required digit position of the frequency indicator and **click left mouse button** - digit position value will one up.

Rollover mouse cursor on the required digit position of the frequency indicator and **click right mouse button** - digit position value will one down.

- **Rotating mouse wheel on the digit position of the frequency indicator.**
 Rollover mouse cursor on the required digit position of the frequency indicator and **rotate mouse wheel forward** - digit position value will be increased.
 Rollover mouse cursor on the required digit position of the frequency indicator and **rotate mouse wheel backward** - digit position value will be decreased.
- **Mouse wheel click on the digit position of the frequency indicator.**
 Rollover mouse cursor on the required digit position of the frequency indicator and **click mouse wheel** - lower digit positions will turn 0.
- **Synchronous frequency tuning by the click on the Band Scope.**
 Rollover mouse cursor on the required position on the spectrum scope or waterfall of the Band Scope, then click with the left mouse button - receiver's filter will move to this position.

7.3 Adjusting the AF gain

Adjust the overall transceiver volume with the help of the **AF** knob, on the front panel of the transceiver (marked with the red circle).



Separate volume adjusting for each VFO is carried out in the MIXER menu (more details in [Audio signals routing](#)^[151]).

Note:



- ☎ Rotate the knob clockwise to increase the volume, counter clockwise to decrease the volume.
- ☎ In some cases volume might equal 0:
 CTSS receiver's tone differs from the received signal tone - set the receiver's tone value the same as the received signal value.
 SQL level is higher than the received signal level - lower the **SQL** trigger threshold.
- ☎ Adjusting the volume with the **AF** knob does not apply to the volume of the internal PC audio (more details in [Audio signals routing](#)^[151]).

7.4 Adjusting the RF gain

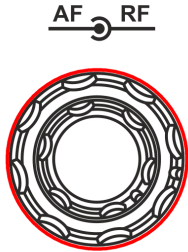
Adjust the **AGC** gain by rotating the **RF** knob on the front panel of the transceiver (marked with the red circle).



Note:



-  Set the max **AGC** gain level, that the air noise level is at its minimum.
-  When the **AGC** is **OFF** , **RF** knob controls the **IF** gain.

7.5 Muting the received audio

Mute the transceiver by pressing **MUT** button (marked with the red rectangle). Turn on the sound by pressing **MUT** button again.



Note:

-  Pressing **MUT** button will turn off only transceiver volume. To turn off internal PC volume use special button with function 

7.6 Internal speaker On/Off

Turn on/off the **internal speaker** with the **SPEAKER** button in the MIXER local panel (more details in [MIXER](#)⁶⁷).

Press the **SPEAKER** button to turn on the **internal speaker** (speaker is on - green button).

Note:

*📞 Sound output to the internal speaker is possible only if the **SPEAKER** button is active in the **MIXER** menu. Sound output to the internal speaker does not depend on the presence of the phone's jack connector in the **PHONES** jack on the front panel.*

*📞 Sound output to the phones via the **PHONES** jack is constant and does not depend on the **SPEAKER** button state.*

7.7 Audio signals routing

The transceiver has two signal generators: SDR-module, internal PC.

Volume of the internal PC can be adjusted with the mouse and standard Windows controls or with the special functional buttons (e.g. the example of the special buttons below).



Control and routing of the audio signals of the SDR-module is carried out in the MIXER local panel.

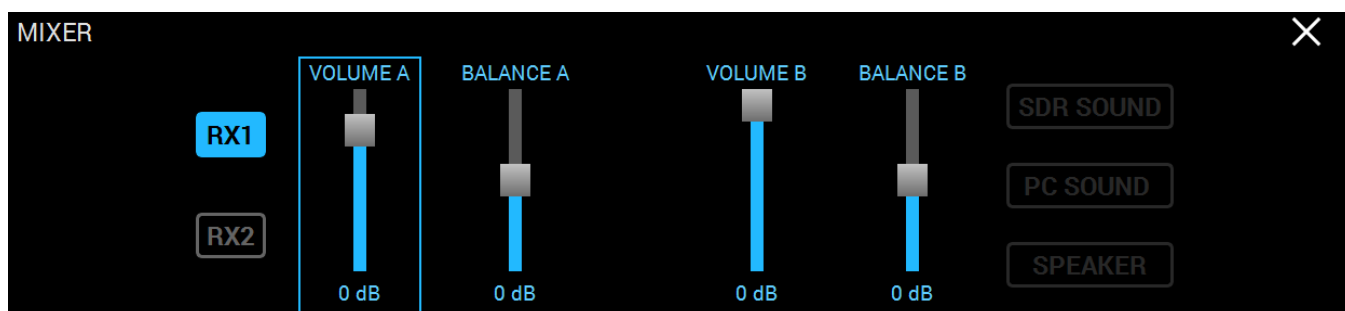

Note:

*📞 You can adjust the volume and balance when the **SubRX** is enabled. When the **SubRX** is disabled the overall volume control is active with the AF knob.*

BALANCE B - VFO B volume balance control between left and right channels.

- **RX1** - Enable RX1 volume and balance controls.
Press the **RX1** to enable volume and balance control for VFO A, VFO B of the RX1.
- **RX2** - Enable RX2 volume and balance controls.
Press the **RX2** to enable volume and balance control for VFO A, VFO B of the RX2.
- **VOLUME A** - VFO A volume control.
Set the required volume for the VFO A receiver.
- **BALANCE A** - VFO A volume balance control between left and right channels.
Set the required volume balance control between left and right VFO A channels.
- **VOLUME B** - VFO B volume control.
Set the required volume for the VFO B receiver.
- **BALANCE B** - VFO B volume balance control between left and right channels.
Set the required volume balance control between left and right VFO B channels.
- **SDR SOUND** - Audio output from the transceiver.
Press the **SDR SOUND** to listen to the transceiver's received signals.
- **PC SOUND** - Audio output from the PC.
Press the **PC SOUND** to listen to the audio from PC, e.g. audio, video files, web browsing, SKYPE etc.
- **SPEAKER** - Audio output to the speaker.
Press the **SPEAKER** to listen to the audio via the speaker.

7.8 Selecting the Operating Band

Select the operating band by pressing the **band buttons** on the front panel of the transceiver.

You can use the following band buttons: **160, 80, 40, 30, 20, 17, 15, 12, 10, 6, 2 Meters**. Press the button of the required band to switch to it.

Note:

 *Band buttons have 3 position memory. Successive presses of the band button cycles through memory position (more details in [Using the Band Memory](#)¹⁵³).*

7.9 Using the Band Memory

Band buttons have 3 position memory.

When you press the band button, receiver switches on this band - frequency stored in the first band memory.

Successive presses of the band button cycles through memory position.

Band(M)	Default (MHz) and Mode		
	Band Memory 1	Band Memory 2	Band Memory 3
160	1.81/CW	1.87/LSB	1.95/LSB
80	3.51/CW	3.65/LSB	3.7/LSB
40	7.005/CW	7.07/LSB	7.1/LSB
30	10.1/CW	10.12/CW	10.13/CW
20	14.001/CW	14.15/USB	14.2/USB
17	18.068/USB	18.1/USB	18.15/USB
15	21.001/CW	21.1/USB	21.15/USB
12	24.89/USB	24.92/USB	24.96/USB
10	28.001/CW	28.3/USB	29/NFM
6	50.001/USB	51.0/NFM	52.0/NFM
2	144.1/CW	144.5/USB	145.5/NFM
Gen	2.5/AM	5.0/AM	15.0/AM

Note:

 When you change the frequency and switch to another band, the transceiver saves the last tuned frequency in the current band memory.

7.10 Selecting the Operating Modes

Selecting the Operating Modes - is carried out with the help of **MD**, **MU** buttons on the front panel of the transceiver (marked with the red rectangle).



MD - Button to switch modulation type Down the list.

Press the **MD** button to select the previous modulation type Down the list.

Press again to cycle through the modulation types.

MU - Button to switch modulation type Up the list.

Press the **MU** button to select the next modulation type Up the list.

Press again to cycle through the modulation types.

Note:

 The selection has an order : **AM, SAM, DSB, LSB, USB, CW, NFM, WFM, SPEC, DIGL, DIGU, DRM** .

While the **USB** mode is active, pressing the **MU** button will switch on next mode - **CW** .

Selecting the mode type from the list - is carried out from the drop down menu.

Rollover mouse cursor on the mode type indicator on the transceiver's display (marked with the red rectangle) and press left mouse button.



Select the required mode type from the drop down menu.

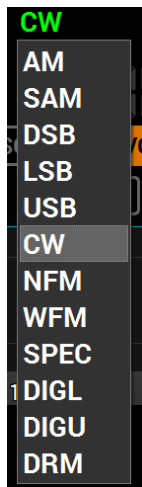

Note:

 You can operate this menu with mouse or your fingers, touching the screen.

The list of the supported mode types in the MB1 transceiver (new modes may be added in the future software releases):

- **AM** - Amplitude modulation.
- **SAM** - Synchronous amplitude modulation.
- **DSB** - Double Side Band.
- **LSB** - Lower Side Band.
- **USB** - Upper Side Band.
- **CW** - CW mode.
- **NFM** - Narrow FM.
- **WFM** - Wide FM. Supports receiving of the stereo signals.
- **SPEC** - Spectrum mode.
- **DIGL** - Digital Lower Side Band (for working in digital modes).
Connect third-party software (is not supplied) to the transceiver software for working in digital modes.
- **DIGU** - Digital Upper Side Band (for working in digital modes).
Connect third-party software (is not supplied) to the transceiver software for working in digital modes.

- **DRM** - Digital Radio Mondiale, 10 kHz filter with 5 kHz IF to work with external decoder of the DRM signals.
Connect third-party software (is not supplied) to the transceiver software for decoding of the DRM signals.

Note:

- ☎ To work in digital modes use **DIGL** and **DIGU**. Mic **AGC** gain, **COMP** and **EQ** can distort the TX digital signal, that's why they are automatically disabled in this modes.
- ☎ Also in **DIGL** and **DIGU** modes you can save your TX and RX filter width.

7.11 ATT/PREAMP control

Attenuator and preamplifier switching - is carried out by pressing the **ATT** button on the front panel of the transceiver (marked with the red rectangle).

Successive presses of the **ATT** button cycles upwards the attenuation coefficient in the following order: **-20dB, -10dB, 0dB, +10dB**.

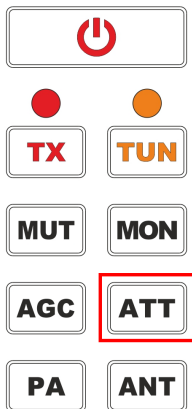

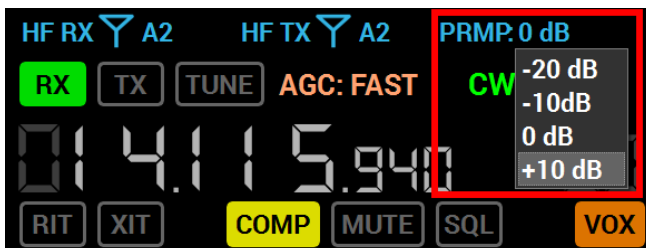

Attenuator and preamplifier switching in the software - is carried out by pressing on the **PRMP** indicator: with the current attenuation coefficient (marked with the red rectangle).
Select the required attenuation coefficient from the drop down menu.



Note:

 Receive quality and overload capability of the receive path in the presence of the powerful signals, depend on the correct attenuation coefficient of the transceiver's receive path.

 For the quality receiving, air noise should surpass the receiver's own noise on 10-15 dB. Disable the receive antenna and make sure that are noise level got lower on 10-15 dB to match receiver's noise level. Lowering of the noise much lower (20-50 dB) means that you set exceedingly high receiver attenuation, it may lead to receiver's overload with powerful signals.

 Receiver's overload with powerful signals is expressed as a rapid rise of the receiver noise level above air noise level on 20-40 dB and lowering to the normal values if the overload emitter is off.

Overload emitter may be beyond the receiver's panorama, you can find it wit the help of the Band Scope.

7.12 Selecting AGC presets

MB1's receiver has **AGC**, which triggers only by the receive signals in RX filter bandwidth. For the signals with different speed of rise and fall, use different speed of **AGC** settings.

Selecting AGC presets - is carried out by pressing the **AGC** button on the front panel of the transceiver (marked with the red rectangle).

Successive presses of the **AGC** button cycles the **AGC** presets in the following order: **OFF**, **LONG**, **SLOW**, **MED**, **FAST**, **USER**.



AGC presets:

- **OFF** - AGC is off.
Set this **AGC** preset, if you need to switch off the **AGC**.
-

Note:

 If the **AGC** is **OFF**, **RF** knob will adjust the **IF** gain.

- **LONG** - Long AGC.
Set the **LONG** preset to use long **AGC** reaction (approximately 750 ms). Recommended for phone modes.
 - **SLOW** - Slow AGC.
Set the **SLOW** preset to use slow **AGC** reaction (approximately 500 ms). Recommended for phone, digital modes.
 - **MED** - Medium AGC.
Set the **MED** preset to use medium **AGC** reaction (approximately 250 ms). Recommended for CW, digital modes.
 - **FAST** - Fast AGC.
Set the **FAST** preset to use fast **AGC** reaction (approximately 100 ms). Recommended for CW, digital modes.
 - **USER** - Custom AGC.
Set the **USER** preset to use custom **AGC** reaction (by default the slowest 1000 ms).
-

Note:

 AGC settings influence the quality of the received signal. Be careful selecting the AGC preset or tuning your own preset.

7.13 Frequency Tuning Lock

Frequency Tuning Lock - is carried out by pressing the LOCK button on the front panel of the transceiver (marked with the red rectangle).

LOCK - Frequency Tuning Lock button.

Press the **LOCK** button to lock the frequency. This also blocks bands changes.

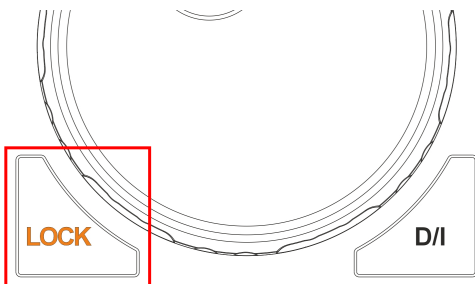

7.14 VFOA and VFOB control

Each RX1 and RX2 receiver has two tune sub-receivers VFO A and VFO B.

- The **Main Knob** controls **VFO A** frequency of the RX1 receiver by default.
- **MULTI 3** knob controls **VFO B** frequency of the RX1 receiver.
To listen to the **VFO B** frequency press the **SubRX** button on the front panel of the transceiver.
- When the **A/B** mode is enabled, the **Main Knob** controls **VFO B** frequency of the RX1, the **MULTI 3** knob controls **VFO A** frequency of the RX1 receiver.
Turn it on by pressing the **A/B** button on the front panel of the transceiver (marked with the red rectangle).

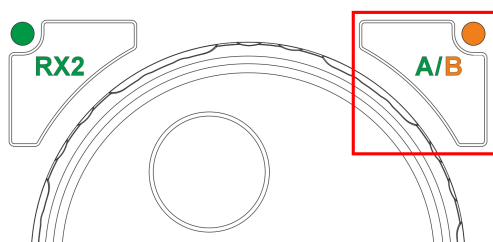

- In the **RX2** mode (more details in [Front Panel Description, paragraph 21^{D31}](#)) the **Main Knob** controls **VFO A** frequency of the RX2 receiver.
- **MULTI 3** knob controls **VFO B** frequency of the RX2 receiver.
- In the **RX2, A/B** modes the **Main Knob** controls **VFO B** frequency of the RX2, the **MULTI 3** knob controls **VFO A** frequency of the RX2 receiver.

- If the Sub-receiver or the SPLIT mode is enabled, then for the Fast tuning by the mouse click between VFO A and VFO B press the mouse wheel on the spectrum scope or waterfall. While tuning, color of the mouse cursor will match the controlled receiver - color of the mouse cursor also match the receiver's tuning line.

VFOA and VFOB control knobs are placed on the front panel of the transceiver (marked with the red rectangle).

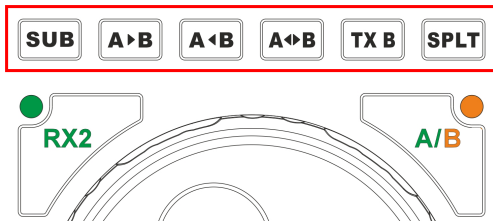

- **SUB** - Sub-receiver button.
Press the SUB button to enable the sub-receiver. Controlled via VFO B (more details in [Sub-receiver using \$D^{188}\$](#)).

Note:

← Reception will function in the panorama's bandwidth.

- **A>B** - Button to assign the frequency from heterodyne VFO A to heterodyne VFO B.
Press **A>B** button to assign the frequency from heterodyne VFO A to heterodyne VFO B.
- **A<B** - Button to assign the frequency from heterodyne VFO B to heterodyne VFO A.
Press **A>B** button to assign the frequency from heterodyne VFO B to heterodyne VFO A.
- **A<>B** - Button for frequency exchange between VFO A and VFO B.
Press **A<>B** to exchange the frequency values between VFO A and VFO B.
- **TX B** - Button to activate Transmission mode in Sub-receiver.
Press **TX B** button to activate the transmission mode of Sub-receiver.
Press again **TX B** button to return the transmission mode to heterodyne VFO A.
- **SPLIT** - Button to enable SPLIT.
Press the **SPLIT** button to activate reception mode on the separate frequencies.

7.15 Changing RX Filter width by knob

Changing the RX Filter width - is carried out with the help of the **WIDTH** knob.

Rotate the **WIDTH** button clockwise to widen the filter, counter clockwise to narrow the filter.

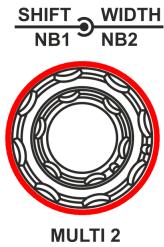

7.16 RX Filter Shifting

RX Filter Shifting - is carried out with the help of the **SHIFT** knob.

Rotate the **SHIFT** button clockwise to shift the filter right, counter clockwise to shift the filter left.

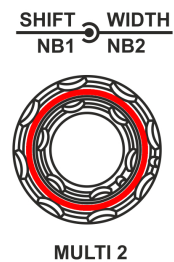

Note:

☎ At the bottom (on the low frequency) filter width is limited by the tuning frequency and cannot be shifted or widened beyond the limits.

7.17 Select RX Filter presets

Choosing RX Filter presets - is carried out with the help of the **FU** and **FD** buttons.

Press the **FU** button to select the next in the list, wider receiver's filter.

Press the **FD** button to select the previous in the list, narrower receiver's filter.

Note:

☎ The last in the list - the widest, is the User filter, it can be tuned by your own wish and can vary in the filter width from the default value.

Select the receiver's filter from the list, which vary depending on the mode type:

Presets for CW mode (Hz): 50, 100, 250, 400, 500, 650, 800, 1000, 1200, User.

Presets for SSB modes (LSB,USB)/DIGL/DIGU (kHz): 1.8, 2, 2.2, 2.5, 2.7, 2.9, 3.0, 3.3, 3.5, User.

Presets for AM/SAM/DSB/NFM modes (kHz): 3, 3.5, 4, 5, 6, 8, 10, 12, 16, User.

Presets for WFM mode (kHz): 150, 200, 250, 260, 270, 280, 290, 300, 310, User.

Presets for DRM mode (kHz): 10.

Presets for SPEC mode: none, because in this mode you receive the whole spectrum scope.

Note:

 Band cannot exceed sample rate value set for the audio device in VAC settings.

7.18 ZOOM-In ZOOM-Out the graphics

Zoom the receiver panorama with buttons - Z+, Z-

Press **Z+** to zoom in the transceiver's panorama and more detailed signals.

Press **Z-** to zoom out the transceiver's panorama and see a "big picture".

Zoom the receiver panorama with mouse - is carried out with the mouse connected to the transceiver.

Right mouse button:

1. Rollover the mouse cursor on any place of the frequency scale separating the spectrum and waterfall (cursor will become open hand).
2. Press the right mouse button (cursor will become two-sided needle).
- 3.a. Holding down the right button pressed, drag the mouse **right to zoom in**.
- 3.b. Holding down the right button pressed, drag the mouse **left to zoom out**.

Note:

 Zoom in of the panorama is carried out relative to the Zoom Position marker, which is equal to the tuned frequency of the VFO A receiver by default.

You can move the Zoom Position with your mouse:

- holding the Zoom Position marker with the left mouse button;
- press the mouse wheel on the required frequency scale between the spectrum and waterfall.

7.19 Squelch level adjusting

Squelch trigger threshold adjusting - is carried out by rotating the SQL knob on the front panel of the transceiver.

Rotate the SQL knob to set the required squelch trigger threshold.

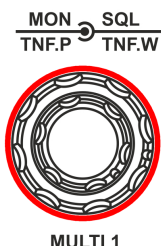

SQL threshold level is displayed on the S-meter as the yellow needle. If the air signal - green needle, surpasses the SQL trigger threshold - yellow needle, then you'll hear the sound of the received station on the receiver's LF output. If the signal level is lower than the trigger threshold you'll hear nothing.



7.20 Adjusting RX Equalizer

Adjusting 18-band RX Equalizer - is carried out via the **RX Equalizer** local panel.

Press and hold the **R.EQ** button on the front panel of the transceiver to open/close the local panel.

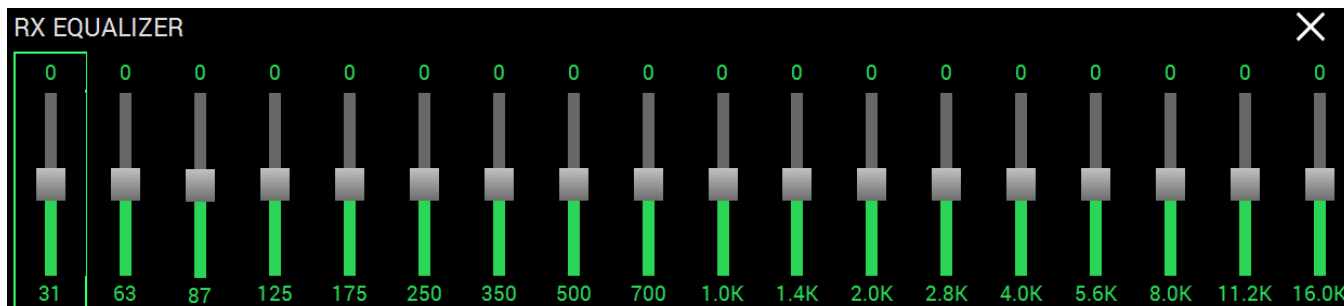



Set the required response for each RX equalizer frequency.

By rotating the **Multi 1** knob, choose the band which you want to adjust - marked with the green rectangle.

By rotating the **Multi 2** knob set the required level for each band.

Note:

 *Equalizer tuning could be performed with the help of the mouse, by dragging the equalizer slider up and down.*

 *Also equalizer tuning could be performed with the help of the transceiver's touch-screen panel, by dragging the equalizer slider up and down with your finger. пальца руки.*

7.21 DSP Functions

MB1 transceiver has several Digital Signal Processing functions for improving received signals.

The list of the available DSP functions:

- **NR** - Noise reduction.
Adaptive filter for the noise-like crosstalks, allows to clear the signal from the crosstalks.
 - **NB1** - First Noise Blanker .
Noise Blanker with approximation - algorithm 1.
 - **NB2** - Second Noise Blanker.
Noise Blanker with approximation - algorithm 2.
-

Note:

 *The **NB1** and **NB2** algorithms are different. Try each of them to reach the best impulse interference reduction.*

***NB1** and **NB2** Noise Blankers can also be used simultaneously.*

 ***NB1** and **NB2** thresholds could be adjusted in the software settings (more details in [DSP tab](#) ⁶⁹) or with the knobs on the front panel of the transceiver (will be available in the new software releases).*

- **ANF** - Automatic Notch Filter.
Adaptive reject filter for the periodic signals/crosstalks - narrowband, carrier, CW and other signals.
-

Note:

 *If there are no interference, **ANF** could slightly affect the reception quality of the desired signal. Disable **ANF** , if you don't need it.*

- **TNF** - Tuning Notch Filter. *Will be available in the new software releases .*
Manual reject filter with adjusted rejection bandwidth.
- **BIN** - Binaural mode.
In one of the headphone channels, the signal will be shifted in phase on 90 degrees.
- **APF** - Analog Pick Filter.
Analog peak-filter creates the triangle filter's AFC (amplitude-frequency characteristic) in the filter bandpass.
- **DSE** - Digital Surround Effect.
Digital Surround Effect for CW signals. Provides a space orientation in stereo phones, stations from lower frequencies are louder in the left channel, stations from higher frequencies are louder in the right channel. Signal in the filter's center is equally heard in both channels of stereo phones.

This algorithm provides panorama acoustic of the CW signals in the filter bandwidth, depending on their position in the filter:

- if the received CW signal is in the receive filter bandwidth and lower the tuned frequency, it will be louder in the left phone;
- if the received CW signal is in the receive filter bandwidth and higher the tuned frequency, it will be louder in the right phone;
- if the received CW signal is in the receive filter bandwidth and in the middle of the tuned frequency, it will be equally load in both ears.

7.22 Meter

Signals' level meter - is the main indicator of the RX, TX, MIC levels, SWR level etc.

List of the measured parameters:

S-meter - Displays (in units) the level of the received signals in the receiver filter bandwidth.

PWR - Displays (in Watts) the level of the output power in TX mode.

SWR - Displays the SWR level with load in TX mode (blue bar).

MIC - Displays (in dBW) level of the MIC signal before modulator (green bar).

SQL - RX signals threshold needle to open SQL.

7.23 IQ files recording

IQ-files recording is required for storing the RX bandwidth panorama. Recorded file could be played later with applying any known mode type.

IQ files recording - files are stored in the internal PC' SSD.

Press the **IQ** button on the front panel of the transceiver, to start recording the IQ-file.

When the IQ-file recording starts, indicator flashes - **IQ** , to the right of S-Meter.

Press the **IQ** button again to stop recording.

By default IQ-files are stored over the following address: C:\Users\Name_PC\ExpertSDR2\MB1\wave\

Note:

 IQ-files are stored separately for each RX1 and RX2 receiver .

 File name indicates - frequency and record date.

Attention!

 **Continuous recording of IQ-files, could lead to using all available free disk space on your PC!**

7.24 Frequency Tuning STEP Changing

You can tune the frequency of the MB1 transceiver with the different step per one encoder clack.

There is a step indicator in the left part of the software main window.

STEP: AUTO

AUTO mode is set by default - it automatically determines the tuning step according to the speed of the encoder knob rotation.

With the help of the **STEP** button on the front panel of the transceiver you can change the tuning step.

Press the **STEP** button several times to select requires tuning step.

7.25 Front End filters switching

Receiver's hardware has a set of sub-octave band filters for the HF band, narrow band filter for the 2M band and wide filters for all Nyquist zone 0...65 MHz, 95...148 MHz.

Depending on the task, user can enable either filters by pressing the **WF** button on the front panel of the transceiver.

WF - Wide/narrow band filter switch button on the receiver's input.

Press the **WF** button to enable wide filter with bandwidth 0...65 MHz (for HF) and 95...150 MHz (for VHF).

Note:

 If the **WF AUTO** mode is enabled setting , then **WF** button won't function.

You can control filter switching via the **Front End Settings** local panel.

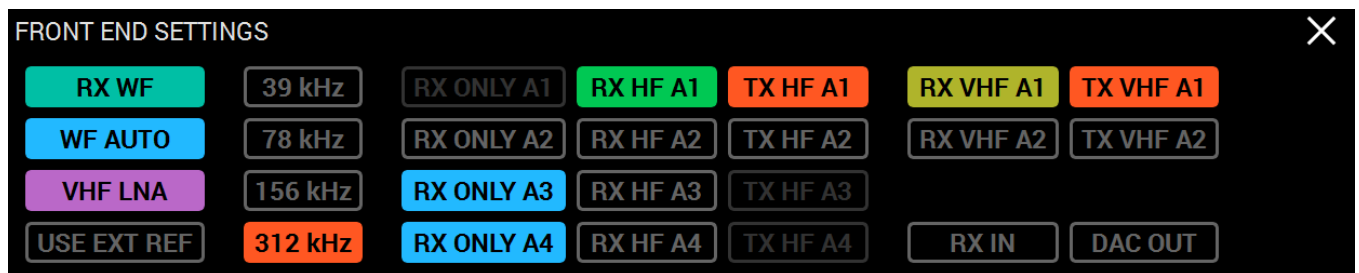

RX WF - Wide band filter enable button.

Press the **RX WF** button to enable wide filter for all HF band (0...65 MHz) or VHF band (95...155 MHz) - receiver automatically selects HF or VHF, depending on the tuning frequency.

WF AUTO - RX WF auto-enable button.

Press the **WF AUTO** button to let the wide filter auto-enable when you use wide Band-Scope and/or second receiver on the other band.

7.26 Antenna switching

There are a couple of ways to switch the antennas in the transceiver:

ANT - Antennas switch button.

Short press the **ANT** button for synchronized (RX and TX) antenna switch. Successive presses cycles through the antennas.

Press and hold the **ANT** button to open the antenna switch local panel (see the picture below).

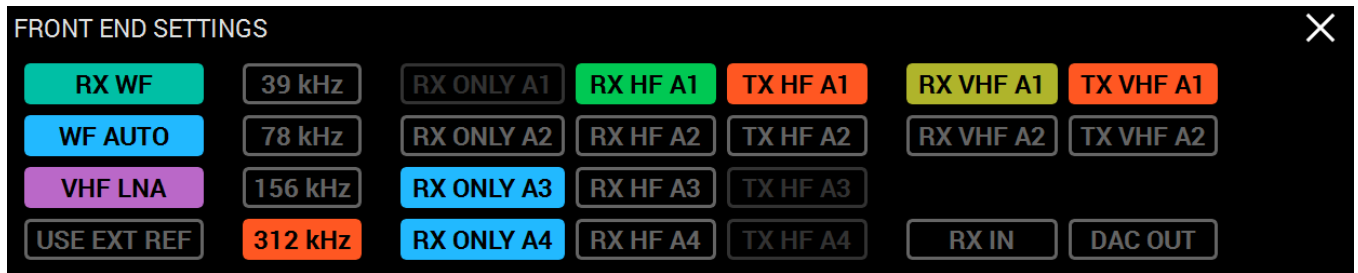

With either the mouse cursor or via touch screen you can press these buttons:

RX HF A1...RX HF A4 - Buttons to select antenna for RX mode in HF band.

Press one of the **RX HF A1...RX HF A4** buttons to select the antenna for RX mode in HF band (0...80 MHz).

TX HF A1...TX HF A4 - Buttons to select antenna for TX mode in HF band.

Press one of the **TX HF A1...TX HF A4** buttons to select the antenna for TX mode in HF band (in amateur bands).

RX ONLY A1...RX ONLY A4 - Buttons to set the **RX ONLY** mode for the HF antenna inputs.

Press **RX ONLY A1...RX ONLY A4** buttons to select the **RX ONLY** mode to the corresponding antenna inputs in HF band (0...80 MHz).

Note:

 When setting the **RX ONLY** mode for the antenna inputs, you can select 3 antenna inputs maximum. One antenna input should be assigned for the TX mode.

 When setting the **RX ONLY** mode for the antenna inputs, TX mode is automatically locked for them.

RX VHF A1...RX VHF A2 - Buttons to select antenna for RX mode in VHF band.

Press one of the **RX VHF A1...RX VHF A2** buttons to select the antenna for RX mode in VHF band (95...155 MHz).

TX VHF A1...TX VHF A2 - Buttons to select antenna for TX mode in VHF band.

Press one of the **RX VHF A1...RX VHF A2** buttons to select the antenna for TX mode in VHF band (2M band).

Antenna switch with the help of the **functional buttons F1-F10** on the front panel of the transceiver.

Select, with the mouse or with your finger via the touch-screen, any function **RX ANT**, **TX ANT**, **RX A1...RX A4** in the pop-up menu for the **functional buttons F1-F10**. After selecting the certain function you can control the antenna switch by pressing the **functional buttons F1-F10** on the front panel of the transceiver (more details in [Functional buttons using](#)^{□170}).

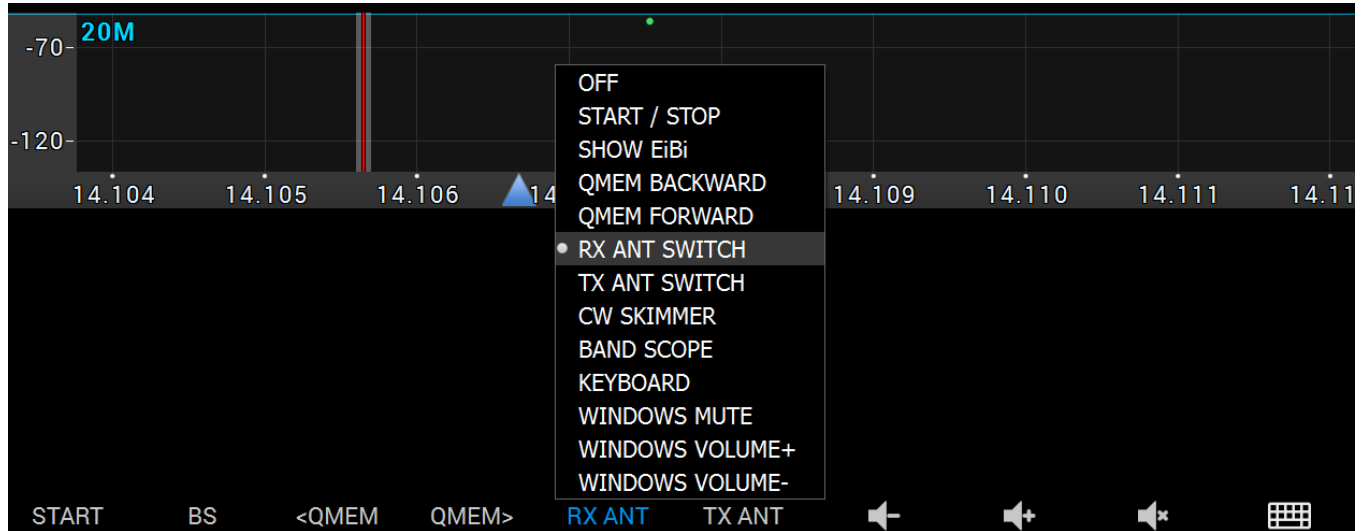

7.27 Using RX IN input

You can enable the receiver's direct input via the **FRONT END SETTINGS** local panel. Press and hold the **ANT** or **ATT** button to open the panel.

RX IN - Receiver's direct input enable button (high-speed ADC input).

Press the **RX IN** button to enable the receiver's direct input, which can be used with receive antennas, external filters, UHF, converters (more details in [RX IN and RX OUT](#)^{□26}).

7.28 Using RX OUT output

You can enable the receiver's HF path output via the **FRONT END SETTINGS** local panel. Press and hold the **ANT** or **ATT** button to open the panel.

RX OUT - Receiver's HF path output enable button (antenna output via band filters, attenuators).

Press the **RX OUT** button to enable the receiver's HF path output, which can be used with additional external filters, UHF, converters etc (more details in [RX IN and RX OUT](#)^{□26}).

7.29 Functional buttons using

MB1 transceiver functional buttons widen the control capability and make the overall usage more comfortable.

The transceiver has two groups of the functional buttons:

- **F1-F10** - functional buttons on the front panel of the transceiver.
- **F11-F21** - functional buttons on the front panel over the offset button (will be active in the new software releases).

To assign a function for the F1-F10 buttons, click left mouse button (or with your finger via the touch-screen) on the sign over the button. In the appeared list select the required function (see the picture below).

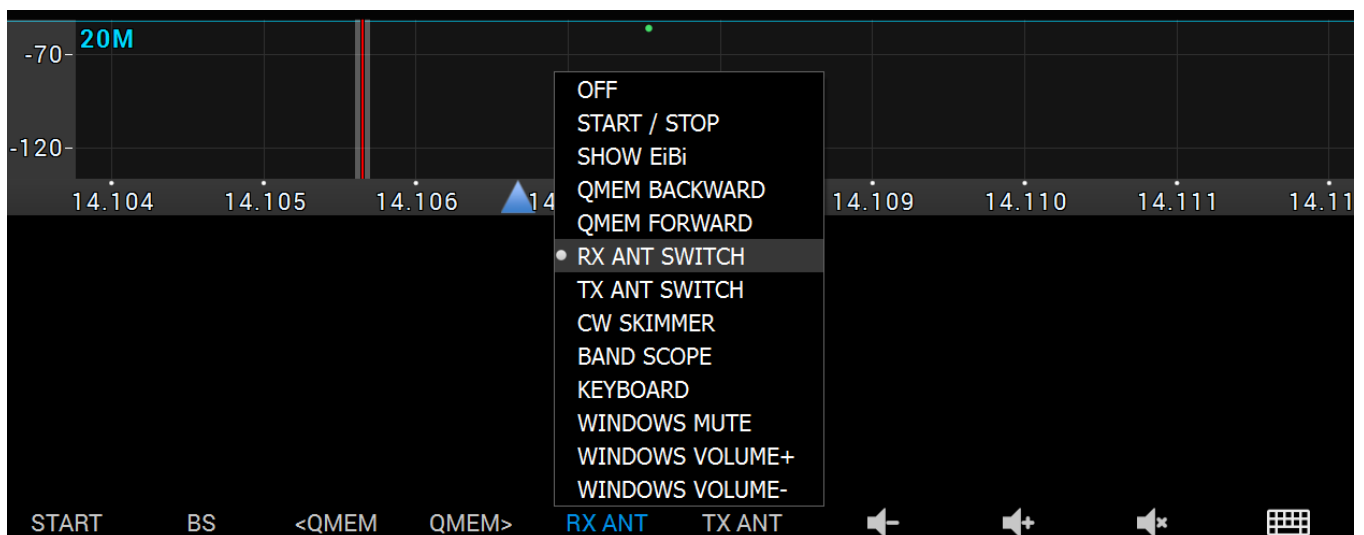

Assigned function will be displayed over the functional button.

The list of the available functions (new functions may be added in the future software releases):

- **OFF** - Function is not assigned.
- **START/STOP** - START/STOP RX mode.
- **SHOW EiBi** - Show the HF stations markers on the panorama from the EiBi data basis.
- **QMEM BACKWARD** - Backward frequency from the quick memory.
Press the **QMEM BACKWARD** button to go to the previous frequency (memorize last 16 frequencies. Frequency is memorized after 2 stand still seconds).
- **QMEM FORWARD** - Forward frequency from the quick memory.
Press the **QMEM FORWARD** button to go to the next frequency (works if earlier you shifted backward from another frequency).

- **RX ANT SWITCH** - Switch to the next RX antenna in the list.
- **TX ANT SWITCH** - Switch to the next TX antenna in the list.
- **RX ONLY A1** - Select RX antenna A1.
Used for HF and VHF bands.
- **RX ONLY A2** - Select RX antenna A2.
Used for HF and VHF bands.
- **RX ONLY A3** - Select RX antenna A3.
- **RX ONLY A4** - Select RX antenna A4.
- **CW SKIMMER** - Make a connection with CW Skimmer.
- **BAND SCOPE** - Enable wide Band-Scope with 80 MHz band.
- **KEYBOARD** - Enable digital Windows keypad.
- **WINDOWS MUTE** - Disable the sound in the internal PC.
- **WINDOWS VOLUME+** - Increase the volume of the internal PC.
- **WINDOWS VOLUME-** - Decrease the volume of the internal PC.

7.30 DRIVE level adjusting

In the MB1 transceiver **DRIVE level adjusting** is carried out by rotating the **DRIVE** knob on the front panel of the transceiver.



DRIVE - Drive output knob (in %).

Rotate the **DRIVE** knob to set the transceiver's output power.

The level of output power displayed in % in the software Main window

DRIVE - Drive output knob (in %).

Rotate the **DRIVE** knob to set the required transceiver's output power. Rotate the **DRIVE** knob clockwise to increase output power, counter clockwise to decrease output power.

Output power in % is displayed in the software Main window on the **PWR: XX%** indicator.

Note:

☎ Output power is stored for each band by default.

☎ Output power in % doesn't always mean the same in Watt, may vary.

7.31 Microphone gain control

In the MB1 transceiver **Microphone gain control** is carried out by rotating the **MIC** knob on the front panel of the transceiver and determines the max coefficient of the microphone AGC gain.

MIC/SPD DRIVE
VOX COMP



MIC - Knob for microphone input (in dB) gain control.

Rotate the **MIC** knob to set the required level of microphone AGC gain. Rotate the **MIC** knob clockwise to increase microphone AGC gain, counter clockwise to decrease microphone AGC gain.

The microphone gain level is displayed in the software Main window.

Note:

- ☎ Set the level of microphone AGC gain, that microphone signal is increased to the -10...-5 dB level on the MIC-meter indicator (green bar).
 - ☎ When the microphone AGC is disabled, **MIC** knob controls the gain by the microphone.
 - ☎ In the telephone modes - knob controls microphone gain, in the CW mode - knob controls the manipulation speed.
-

7.32 Selecting the microphone's input

Selecting the microphone's input - is carried out by the pressing of the **MIC** button on the front panel of the transceiver.

Press the **MIC** button several times to choose the required microphone input **MIC1**, **MIC2**, **MIC PC**.

- **MIC1** - Electret input / linear input.
- **MIC2** - Dynamic input.
- **MIC PC** - Sound card input.

The chosen microphone is displayed in the software Main window on the indicator **MIC PC: 20 dB** there you can see the set level of the microphone AGC gain.

Note:

 Max microphone AGC gain is stored for each microphone input separately.

In the **MIC/CW SETTING** local panel you can see the microphone settings.

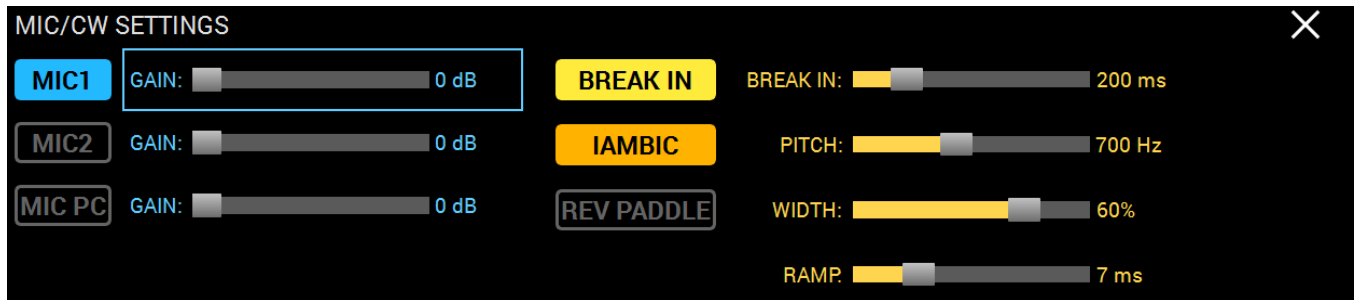

MIC1 - MIC 1 button.

Press the **MIC1** button to choose corresponding microphone.

MIC1 GAIN - Microphone input gain control.

Set the required gain level of the microphone input. Control sets the max microphone's AGC gain, while the microphone AGC is active.

MIC2 - MIC 2 button.

Press the **MIC2** button to choose corresponding microphone.

MIC2 GAIN - Microphone input gain control.

Set the required gain level of the microphone input. Control sets the max microphone's AGC gain, while the microphone AGC is active.

MIC PC - PC's sound card MIC.

Press the **MIC PC** button to choose PC's microphone.

MIC PC GAIN - Microphone input gain control.

Set the required gain level of the microphone input. Control sets the max microphone's AGC gain, while the microphone AGC is active.

7.33 Compression level adjusting

Compression level adjusting is carried out in the **VOX/COMPRESSOR** local panel.

Press and hold the **CMP** or **VOX** button on the front panel of the transceiver to call up the local panel.

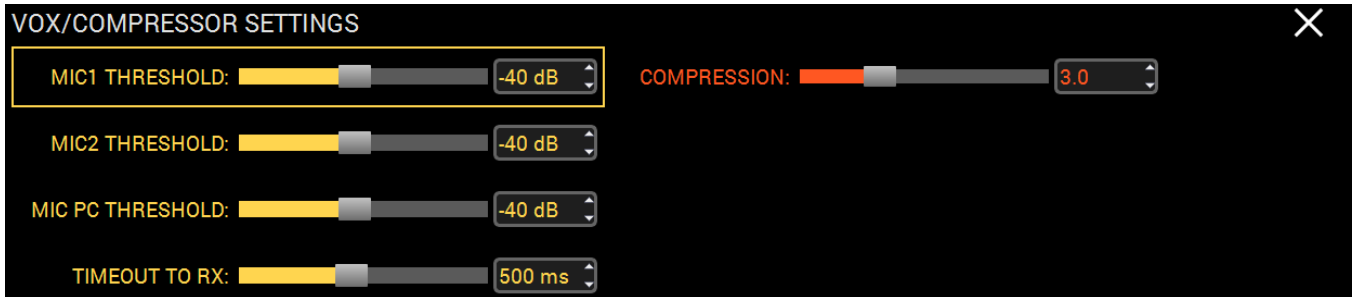

COMPRESSION - Compression of the transmitted signal.

Set the required compression level for the transmitted signal

Note:

- ☎ *The higher the compression level the higher the average power of the voice signal.*
 - ☎ *Check the quality of the generated signal for transmission with TX monitoring function! Excessive **COMP** level may worsen the signal quality!*
 - ☎ *With disabled compressor pick-factor of the voice signal equals 3. That means average/actual power of the voice signal will be 3 times less than the pick values of this signal. On practice it is expressed as slight deviation of the transceiver's power meter needle, approximately on 30W, with max power output. Compressor purpose is to lower the pick-factor, by increasing the compression of the signal, thus increasing the average/actual power. Power meter needle will deviate more.*
-

7.34 VOX Operation

VOX function - switches the transceiver in TX mode when you speak in the microphone.

Enable the VOX function by pressing the **VOX** button on the front panel of the transceiver.

VOX threshold adjusting is carried out in the VOX and Compressor local panel.

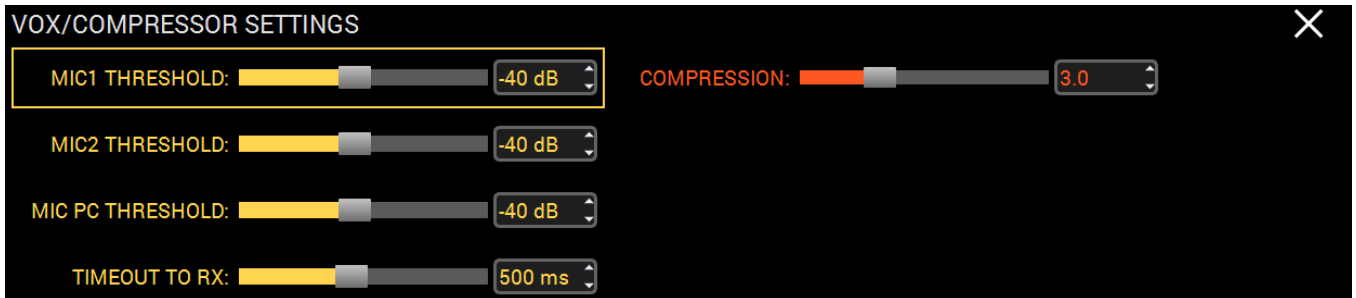

Set the **MIC THRESHOLD** slider in the required position for the active Mic for correct VOX function trigger.

Note:

- Threshold level is set and memorized for each microphone separately.
- VOX - Transmission mode enabled by the voice (Voice-Operated Transmit).

7.35 TX Monitoring Gain

TX Monitoring Gain function allows you to listen to the generated signal and control its quality.

Press the **MON** button on the transceiver's front panel to enable the **TX Monitoring Gain**.

Set the monitoring volume by the **MON** knob.

Rotate the **MON** knob to change the monitoring volume in the TX mode.

Note:

- The **MON** knob will be active only in the TX mode with pressed **MON** button.
- Excessive monitoring volume may lead to the positive acoustic connection between the microphone and headphones (internal dynamic) and as a result to the self-triggering of the audio path.

7.36 Adjusting TX Equalizer

Adjusting the 18-band TX Equalizer - is carried out via the **TX Equalizer** local panel.

Press and hold the **T.EQ** button on the front panel of the transceiver to open/close the local panel.

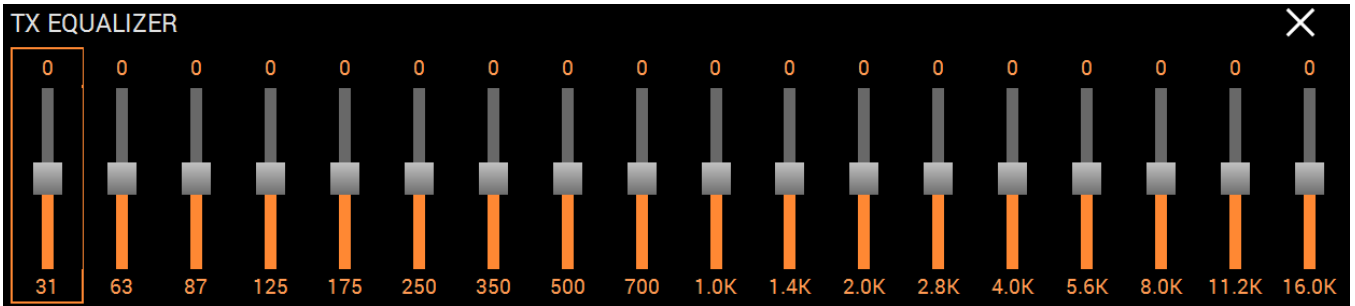



Set the required response for each TX equalizer frequency.

By rotating the **Multi 1** knob, choose the band which you want to adjust - marked with the green rectangle.

By rotating the **Multi 2** knob set the required level for each band.

Note:

-  TX equalizer settings are stored for each microphone separately.
-  Equalizer tuning could be performed with the help of the mouse, by dragging the equalizer slider up and down.
-  Also equalizer tuning could be performed with the help of the transceiver's touch-screen panel, by dragging the equalizer slider up and down with your finger.

7.37 Voice Recorder Operation

Voice recorder allows you to record the signal in the filter bandwidth in the RX mode, and to record the signal from your own microphone in the TX mode.

Record of the receive voice signal:



1. Press the **Rec** button  on the front panel of the transceiver to start the recording. Red LED indicator on the left of the **Rec** button will start blinking.

2. Press again the **Rec** button  on the front panel of the transceiver to stop the recording. Red LED indicator on the left of the **Rec** button will stop blinking.

Note:

 Recording of the received signal is available in all mode types.

Record of the microphone signal:

1. Press the **PTT** button on the microphone or the **TX** button on the front panel of the transceiver.
Transceiver will turn to TX mode.
2. Press the **Rec** button  on the front panel of the transceiver to start the recording and begin to speak in the microphone.
Red LED indicator on the left of the **Rec** button will start blinking.
3. Press again the **Rec** button  on the front panel of the transceiver to stop the recording.
Red LED indicator on the left of the **Rec** button will stop blinking.

Play the recorded signal without transmitting it on air:

1. **Press and hold** (~1 sec) the **Play** button  on the front panel of the transceiver to play the recorded voice signal.
With that in phones (internal speaker) you'll hear the recorded voice signal, meantime receiver will be silent.
2. When the playback ends you'll hear the receiver's air again.



Play the recorded signal with transmitting it on air:

1. **Short press** the **Play** button  on the front panel of the transceiver to play the recorded voice signal and transmit it on the air.
With that the transceiver will turn to TX mode, in phones (internal speaker) you'll hear the recorded voice signal and it will be transmitted on the air.

2. When the playback ends you'll hear the receiver's air again.

Note:

 Attention, recordings of the air signals should be used for personal use only. MB1 operator bears full responsibility for using the recorded signal.

 In the voice Mic you may record your own CQ (come quick) signal and transmit it on the air by pressing the **Play** button .

7.38 Transverter mode operation

Will be available in the future software releases.

7.39 External PA control

The transceiver allows you to control the TX mode of the external power amplifiers (PA).

1. Set the **Enable** checkbox.
 2. Connect the PTT control line of the external PA to one of the PTT sockets (more details in [Linear Amplifier](#)^[21]).
 3. Open the software **Options-> Device** menu-> **PA** tab.
 4. Set the checkboxes for the required bands opposite the used key.
-

Note:

 Choose the electronic keys, which will be activated on the certain bands. The same key could be used on several bands.

 **Example:** If you use wide-band PA 160M-10M bands and control it via the #1 key, then set the checkboxes for the #1 key, opposite the corresponding bands.

There are **PTT** keys settings on the **PA** tab - which control the TX mode of the external power amplifiers (PA).

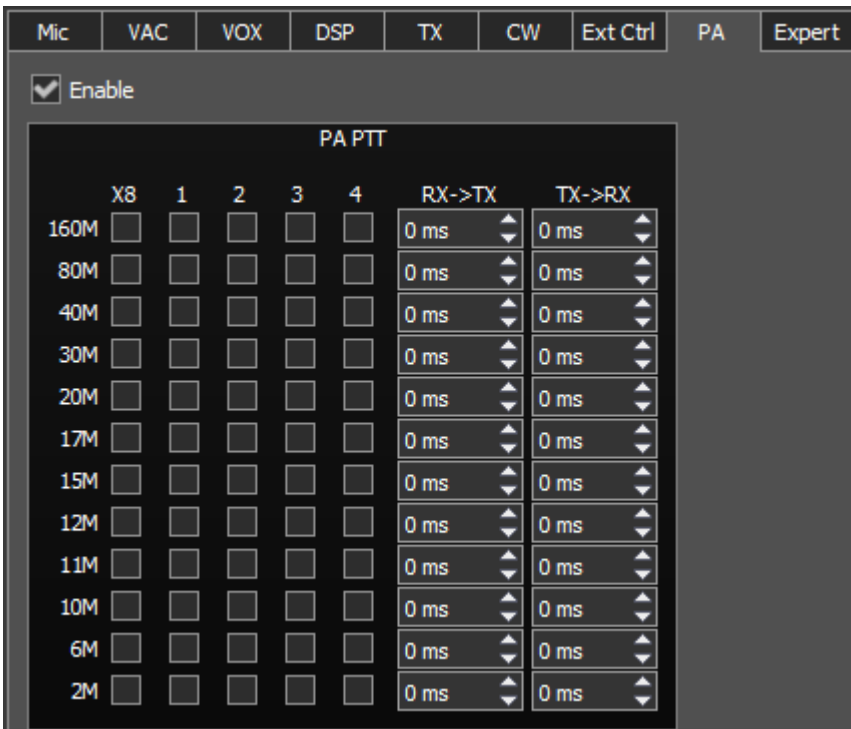

Enable - Checkbox to enable the PTT key control.
Set the **Enable** checkbox to work with the keys.

PA PTT - Category with **PTT** keys settings.

- **X8** - **PTT** control key for external PA control.
Key's output is placed on the rear panel of the transceiver in the EXT CTRL connector (more details in [EXT CTRL](#)²⁹).
- **1...4** - **PTT** control keys for external PAs control.
Keys' outputs are placed on the rear panel of the transceiver on the corresponding PTT 1-4 connectors (more details in [PA PTT outputs](#)³⁰).
- **RX->TX** - HF signal delay after switching from RX to TX.
- **TX->RX** - Switching delay from TX to RX after the PTT signal is off.
- **160M-2M** - Keys' activation checkboxes for the corresponding bands.

7.40 Transmitting in Voice mode

1. Press the **PTT** button on the microphone or the **TX** button on the front panel of the transceiver.
2. Speak in the microphone in a calm tone.
3. Release the **PTT** button on the microphone or press again the **TX** button on the front panel of the transceiver.

Note:

☎ After connecting the PTT footswitch to the PTT connector on the rear panel of the transceiver (more details in [Accessories](#) ¹⁹) you may push the footswitch to turn to transmission. Release the footswitch to stop transmission and return to RX mode.

7.41 Transmitting in CW mode

1. Connect the CW key to the transceiver.
2. Set the CW mode type.
3. Enable the **BREAK-IN** mode on the local panel [MIC/CW SETTINGS](#) ⁶².
4. Use the CW key.

Note:

☎ When you transmit in the CW mode - red TX indicator is flashing.

7.42 DAC OUT operation

DAC OUT is the transceiver's low-power output, works in the wide frequency band.

1. To work with the DAC OUT press the **DAC OUT** button in the local panel of the HF path.
2. Tune on the required frequency.
3. Enable the TX mode by pressing the **PTT** button on the Mic or the **TX** button.

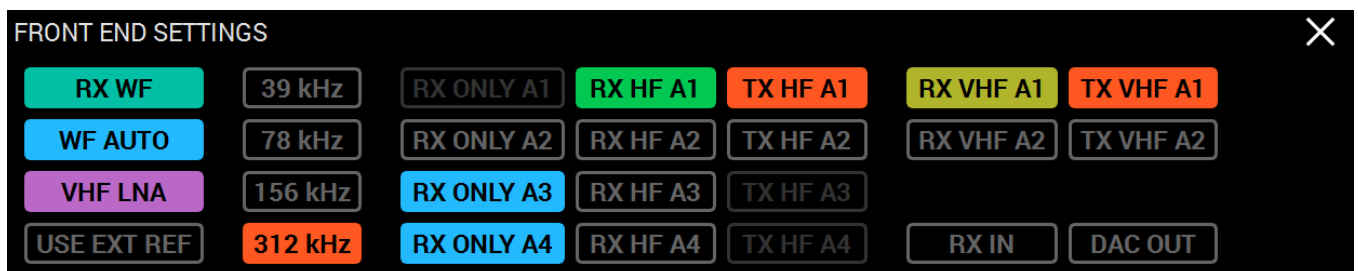

Note:

 The output can be used for connection of the external power amplifiers, transverters and as a generator of the measuring signal.

 Transmission is possible only on the amateur bands.

DAC OUT output parameters:

Frequency band: 0.1...150 MHz

Transmitted signal band: 20 kHz

Impedance: 50 Ohm

Signal level: +10 dBm (max)

7.43 CTCSS Tones using

In some cases it's required to activate the squelch with the help of the **CTCSS** tones.

To operate in the **CTCSS** mode:

1. Set the **NFM** mode.
2. Open the **NFM** local panel and set the receiver's tone frequency with the **RX TONE** slider or enter the required number from the keyboard in the **RX TONE** input box (if required).
 - 2.a. Open the **NFM** local panel and set the transceiver's tone frequency with the **TX TONE** slider or enter the required number from the keyboard in the **TX TONE** input box (if required).
3. Press one of the buttons **RX/TX**, **RX ONLY**, **TX ONLY**:

RX/TX - CTCSS mode is active in RX and TX modes.
RX ONLY - CTCSS mode is active in RX mode.
TX ONLY - CTCSS mode is active in TX mode.
4. Set (if required) required tone level.

By default 15% - common value for this mode.
5. Press the **CTCSS** button to activate CTCSS mode.
6. Receive signals with the CTCSS tone.
 - 6.a. Press the **PTT** button on the Mic or the **TX** button on the front panel of the transceiver to transmit the signals with the CTCSS tone.
7. Release the **PTT** button on the Mic or press the **TX** button again to turn to RX mode.

Press and hold the **MD** or **MU** mode button on the front panel of the transceiver to open/close the **NFM local panel**.

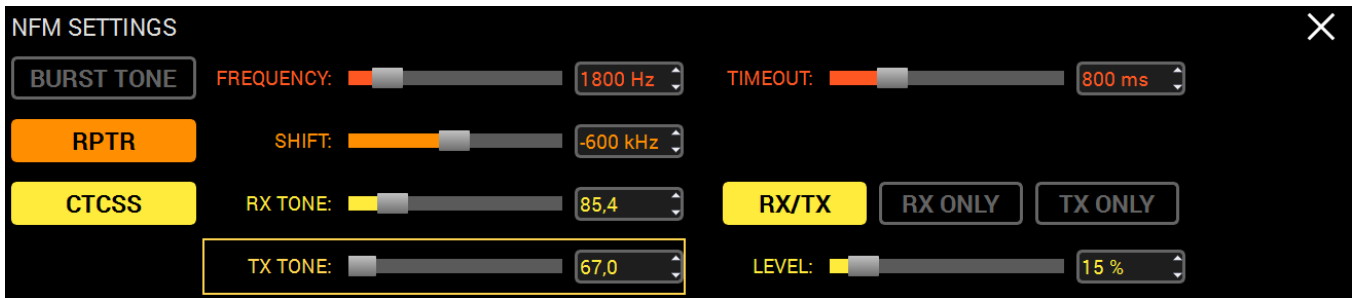

7.44 Burst Tone using

In some cases repeater stops working after some time - goes to "sleep" mode. To wake it from the "sleep" mode you need to send the Burst tone of the exact frequency for some time.

To form a Burst tone:

1. Set the **NFM** mode.
2. Open the **NFM** local panel and set the tone frequency with the **FREQUENCY** slider or enter the required number from the keyboard.

Common value for tone frequency **1800 Hz**, but can vary in some repeaters.

3. Set the required tone TX time, enough for the used repeater, with the **TIMEOUT** slider or enter the required number from the keyboard.

4. Press the **BURST TONE** button.

The transceiver will send the FM signal with the tone, frequency from the **FREQUENCY** value and TX time from the **TIMEOUT** value.

Press and hold the **MD** or **MU** mode button on the front panel of the transceiver to open/close the **NFM local panel**.

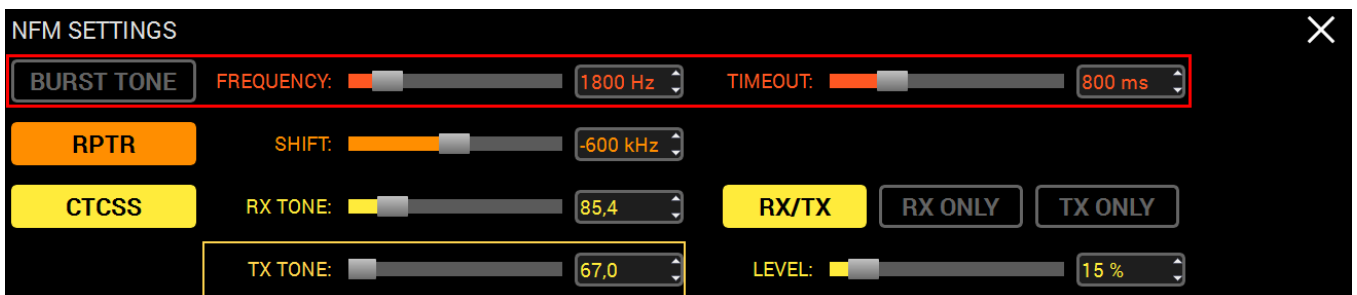

7.45 EXT CTRL Configuration

MB1 transceiver allows you to control external devices via the keys with open collector. In the Key's chain could be connected relay or other executive element, which will enabled/disabled depends on the selected band and/or RX/TX mode.

To start using the keys:

1. Open the **Options-> Device** menu-> **Ext Ctrl** tab.
2. Set the **Enable** checkbox to activate keys functionality.
3. Set the checkboxes for the required bands apposite the corresponding keys.

Note:

 With the help of the keys, you may control relays, antenna switch, band filters, band-decoders, transverters, power amplifiers etc.

 On the picture below you can see an example of using the keys in the 160M, 80M and 40M bands for both RX and TX modes.

While working on the 160M band in the RX mode, #1 key is enabled, if turn to TX mode, #1 key is still active.

While turning on 80M band, #2 key will be enabled (#1 key will be disabled), it is active in both RX and TX modes.

While turning on 40M band, #3 key will be enabled (#2 key will be disabled), it is active in both RX and TX modes.

Connect the relays to these keys, you may create an additional antenna switch, band filters switch, PA band switch etc.

 **GEN** band can be enabled when the tuned frequency is beyond amateur bands frequencies.

Mic	VAC	VOX	DSP	TX	CW	Ext Ctrl	PA	Expert
<input checked="" type="checkbox"/> Enable								
				RX Mode:				
				1	2	3	4	5
160M:	<input checked="" type="checkbox"/>	<input type="checkbox"/>	<input type="checkbox"/>	<input type="checkbox"/>	<input type="checkbox"/>	<input type="checkbox"/>	<input type="checkbox"/>	<input type="checkbox"/>
80M:	<input type="checkbox"/>	<input checked="" type="checkbox"/>	<input type="checkbox"/>	<input type="checkbox"/>	<input type="checkbox"/>	<input type="checkbox"/>	<input type="checkbox"/>	<input type="checkbox"/>
40M:	<input type="checkbox"/>	<input type="checkbox"/>	<input checked="" type="checkbox"/>	<input type="checkbox"/>	<input type="checkbox"/>	<input type="checkbox"/>	<input type="checkbox"/>	<input type="checkbox"/>
30M:	<input type="checkbox"/>	<input type="checkbox"/>	<input type="checkbox"/>	<input type="checkbox"/>	<input type="checkbox"/>	<input type="checkbox"/>	<input type="checkbox"/>	<input type="checkbox"/>
20M:	<input type="checkbox"/>	<input type="checkbox"/>	<input type="checkbox"/>	<input type="checkbox"/>	<input type="checkbox"/>	<input type="checkbox"/>	<input type="checkbox"/>	<input type="checkbox"/>
17M:	<input type="checkbox"/>	<input type="checkbox"/>	<input type="checkbox"/>	<input type="checkbox"/>	<input type="checkbox"/>	<input type="checkbox"/>	<input type="checkbox"/>	<input type="checkbox"/>
15M:	<input type="checkbox"/>	<input type="checkbox"/>	<input type="checkbox"/>	<input type="checkbox"/>	<input type="checkbox"/>	<input type="checkbox"/>	<input type="checkbox"/>	<input type="checkbox"/>
12M:	<input type="checkbox"/>	<input type="checkbox"/>	<input type="checkbox"/>	<input type="checkbox"/>	<input type="checkbox"/>	<input type="checkbox"/>	<input type="checkbox"/>	<input type="checkbox"/>
11M:	<input type="checkbox"/>	<input type="checkbox"/>	<input type="checkbox"/>	<input type="checkbox"/>	<input type="checkbox"/>	<input type="checkbox"/>	<input type="checkbox"/>	<input type="checkbox"/>
10M:	<input type="checkbox"/>	<input type="checkbox"/>	<input type="checkbox"/>	<input type="checkbox"/>	<input type="checkbox"/>	<input type="checkbox"/>	<input type="checkbox"/>	<input type="checkbox"/>
6M:	<input type="checkbox"/>	<input type="checkbox"/>	<input type="checkbox"/>	<input type="checkbox"/>	<input type="checkbox"/>	<input type="checkbox"/>	<input type="checkbox"/>	<input type="checkbox"/>
2M:	<input type="checkbox"/>	<input type="checkbox"/>	<input type="checkbox"/>	<input type="checkbox"/>	<input type="checkbox"/>	<input type="checkbox"/>	<input type="checkbox"/>	<input type="checkbox"/>
GEN:	<input type="checkbox"/>	<input type="checkbox"/>	<input type="checkbox"/>	<input type="checkbox"/>	<input type="checkbox"/>	<input type="checkbox"/>	<input type="checkbox"/>	<input type="checkbox"/>
				TX Mode:				
				1	2	3	4	5
160M:	<input checked="" type="checkbox"/>	<input type="checkbox"/>	<input type="checkbox"/>	<input type="checkbox"/>	<input type="checkbox"/>	<input type="checkbox"/>	<input type="checkbox"/>	<input type="checkbox"/>
80M:	<input type="checkbox"/>	<input checked="" type="checkbox"/>	<input type="checkbox"/>	<input type="checkbox"/>	<input type="checkbox"/>	<input type="checkbox"/>	<input type="checkbox"/>	<input type="checkbox"/>
40M:	<input type="checkbox"/>	<input type="checkbox"/>	<input checked="" type="checkbox"/>	<input type="checkbox"/>	<input type="checkbox"/>	<input type="checkbox"/>	<input type="checkbox"/>	<input type="checkbox"/>
30M:	<input type="checkbox"/>	<input type="checkbox"/>	<input type="checkbox"/>	<input type="checkbox"/>	<input type="checkbox"/>	<input type="checkbox"/>	<input type="checkbox"/>	<input type="checkbox"/>
20M:	<input type="checkbox"/>	<input type="checkbox"/>	<input type="checkbox"/>	<input type="checkbox"/>	<input type="checkbox"/>	<input type="checkbox"/>	<input type="checkbox"/>	<input type="checkbox"/>
17M:	<input type="checkbox"/>	<input type="checkbox"/>	<input type="checkbox"/>	<input type="checkbox"/>	<input type="checkbox"/>	<input type="checkbox"/>	<input type="checkbox"/>	<input type="checkbox"/>
15M:	<input type="checkbox"/>	<input type="checkbox"/>	<input type="checkbox"/>	<input type="checkbox"/>	<input type="checkbox"/>	<input type="checkbox"/>	<input type="checkbox"/>	<input type="checkbox"/>
12M:	<input type="checkbox"/>	<input type="checkbox"/>	<input type="checkbox"/>	<input type="checkbox"/>	<input type="checkbox"/>	<input type="checkbox"/>	<input type="checkbox"/>	<input type="checkbox"/>
11M:	<input type="checkbox"/>	<input type="checkbox"/>	<input type="checkbox"/>	<input type="checkbox"/>	<input type="checkbox"/>	<input type="checkbox"/>	<input type="checkbox"/>	<input type="checkbox"/>
10M:	<input type="checkbox"/>	<input type="checkbox"/>	<input type="checkbox"/>	<input type="checkbox"/>	<input type="checkbox"/>	<input type="checkbox"/>	<input type="checkbox"/>	<input type="checkbox"/>
6M:	<input type="checkbox"/>	<input type="checkbox"/>	<input type="checkbox"/>	<input type="checkbox"/>	<input type="checkbox"/>	<input type="checkbox"/>	<input type="checkbox"/>	<input type="checkbox"/>
2M:	<input type="checkbox"/>	<input type="checkbox"/>	<input type="checkbox"/>	<input type="checkbox"/>	<input type="checkbox"/>	<input type="checkbox"/>	<input type="checkbox"/>	<input type="checkbox"/>

8 ATU OPERATION

Automatic Tuner Unit (ATU) allows to match a load impedance, different from 50 Ohm, with the output 50 Ohm transmitter impedance.

Enable the Tuner in the **ATU SETTINGS** local panel to use it in the TX mode.

1. Press and hold the **TUN** button on the front panel of the transceiver to call up the local panel.

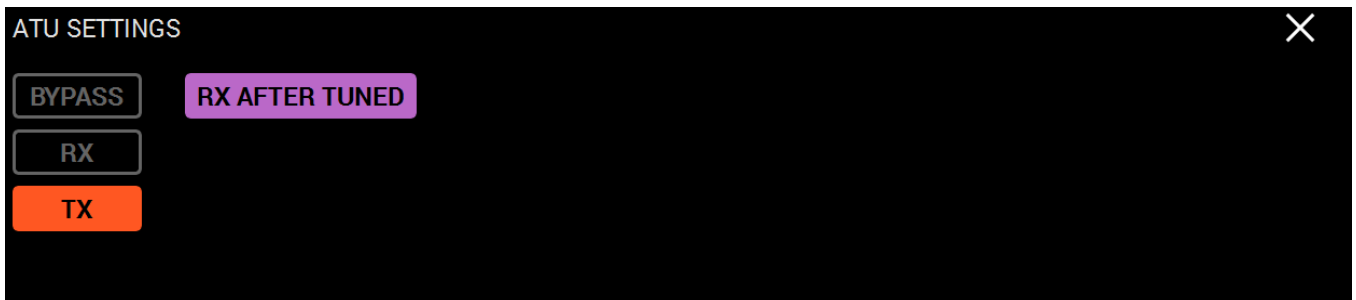

2. Press the **TX** button in the local panel - it will activate the Tuner in the TX mode.
3. Press and hold the **TUN** button or press "X" in the panel top right corner to close the panel.
4. Short press the **TUN** button on the front panel of the transceiver, will activate orange LED above the TUN button.
 Transceiver will turn to TX mode, begin to transmit carrier frequency 15-20 W and tune.
5. After the tuning, transceiver will disable the tuning mode - orange LED above the TUN button will be deactivated.
- 6.a. If the **RX AFTER TUNED** button is enabled, the transceiver will turn to RX mode after tuning.
- 6.b. If the **RX AFTER TUNED** button is disabled, the transceiver will stay in TX mode after tuning.

Warning!

- ① Tuner's states are saved with 50 kHz step!
 - ① Watch for the Tuner and SWR readings, if you need to operate on the other frequency - perform the tuning again!
-

BYPASS - The tuner's Bypass mode button.

Press the **BYPASS** to enable tuner's bypass mode to exclude it's influence on the transceiver.

RX - Enable the Tuner for the RX mode.

Press the **RX** button to enable matching in the RX mode.

Note:

 *The Tuner cannot do matching in the RX mode . The Tuner can only use saved earlier states from the TX mode.*

TX - Enable the Tuner for the TX mode.

Press the **TX** button to enable matching in the TX mode.

RX AFTER TUNED - "RX after tuned" enable button.

Press the **RX AFTER TUNED** button and the transceiver will turn to the RX mode after the tuner is tuned.

9 SPLIT OPERATION

SPLIT operation allows you to receive on the VFO A frequency and transmit on the VFO B frequency.

You can not receive on the VFO B frequency in the SPLIT mode.

To use the SPLIT operation:

1. **Activate the SPLIT mode** by pressing the **SPLIT** button, on the front panel of the transceiver.

Flashing orange **SPLIT** indicator in the main software window means the SPLIT mode is enabled.

2. Set the required transmit frequency (VFO B) in the SPLIT mode (more details in [VFO A and VFO B control](#)¹⁵⁹).

3. Press the microphone PTT button or the TX button on the the front panel of the transceiver to transmit the message.

4. Release the microphone PTT button or press again the TX button on the the front panel of the transceiver to turn to RX mode.

Disable the SPLIT mode by pressing the **SPLIT** button the second time, on the front panel of the transceiver.

Note:

 While in you are in **CW** mode with **BREAK IN** function enabled, the transceiver will turn to TX on VFO B frequency automatically when pressing the CW key.

 While in **digital modes** the transceiver will turn to TX on VFO B frequency automatically if received the PTT signal via the CAT-system or a certain COM-port.

9.1 SPLIT + Sub RX Operation

In some cases you need to transmit in a SPLIT mode and simultaneously listen to the transmit frequency (VFO B), in other words use Sub-receiver.



To enable this mode:

1. **Activate the SPLIT mode** by pressing the **SPLIT** button, on the front panel of the transceiver.

Flashing orange **SPLIT** indicator in the main software window means the SPLIT mode is enabled.

2. **Activate Sub-receiver** by pressing the **SUB** button, on the front panel of the transceiver. Flashing blue **Sub RX** indicator in the main software window means the Sub-receiver is enabled.
3. Set the required transmit frequency (VFO B) (more details in [VFO A and VFO B control](#)¹⁵⁹).
4. Listen to the VFO A and VFO B frequencies simultaneously. If you need to adjust the Volume and Balance of each VFO A and VFO B (more details in [Audio signals routing](#)¹⁵¹).
5. Press the microphone PTT button or the TX button on the the front panel of the transceiver to transmit the message.
6. Release the microphone PTT button or press again the TX button on the the front panel of the transceiver to turn to RX mode.

Note:

-  Sub-receiver's red tuning line means that you'll transmit on the VFO B frequency.
 -  While in you are in **CW** mode with **BREAK IN** function enabled, the transceiver will turn to TX on VFO B frequency automatically when pressing the CW key.
 -  While in **digital modes** the transceiver will turn to TX on VFO B frequency automatically if received the PTT signal via the CAT-system or a certain COM-port.
-

10 SUB RECEIVER USING

If you want to listen the VFO A and VFO B frequencies simultaneously, use Sub-receiver.

1. **Activate Sub-receiver** by pressing the **SUB** button, on the front panel of the transceiver. Flashing blue **Sub RX** indicator in the main software window means the Sub-receiver is enabled.
2. Set the required VFO B frequency (more details in [VFO A and VFO B control](#)¹⁵⁰).
3. Listen to the VFO A and VFO B frequencies simultaneously. If you need to adjust the Volume and Balance of each VFO A and VFO B (more details in [Audio signals routing](#)¹⁵¹).

Note:

 VFO A receiver's red tuning line means that in **Sub-RX** mode you'll transmit on the VFO A frequency.

 To turn the Sub-receiver to transmit, press **TX B** or **SPLIT**.

11 RIT/XIT OPERATIONS

Sometimes you need to use RIT/XIT modes.

11.1 RIT

RIT offset in the RX mode means that transmission will be held on the tuned frequency and receiving frequency will differ by the offset value.

Offset is displayed as a translucent band on the spectrum scope.

RX frequency displayed as the tuned receiver's frequency - green line with the filter band (on the picture below you can see USB mode).

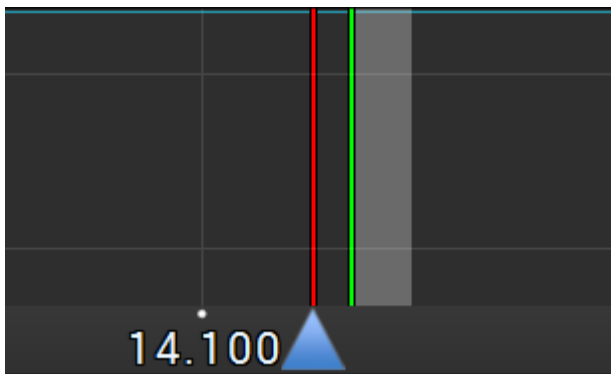

To activate the RIT mode:

1. Short press the **RIT** button on the front panel of the transceiver.
Green indicator under the **RIT** button signals that the mode is active.
2. Rotate the **Multi 3** knob to set the required offset.

Press and hold the **RIT** button for about 0.5-0.8 sec **to return the offset to zero.**

To disable RIT - short press the **RIT** button again.

Idle green indicator under the RIT button signals that the mode is disabled.

Note:

📞 If the **RIT offset wasn't reset**, then if you disable the RIT its state will be saved. When you'll activate the RIT next time, receiver will set the offset according to the previous value.

11.2 XIT

XIT offset in the TX mode means that receiving will be held on the tuned frequency and transmission frequency will differ by the offset value.

Offset is displayed as a translucent band on the spectrum scope.

RX frequency displayed as the tuned receiver's frequency - green line.

TX frequency displayed as the tuned transceiver's frequency - red line with the filter band (on the picture below you can see USB mode).



To activate the XIT mode:

1. Short press the XIT button on the front panel of the transceiver..
Orange indicator over the XIT button signals that the mode is active.
2. Rotate the **Multi 3** knob to set the required offset.

Press and hold the **XIT** button for about 0.5-0.8 sec **to return the offset to zero.**

To disable XIT - short press the **XIT** button again.

Idle orange indicator over the **XIT** button signals that the mode is disabled.

Note:

 If the **XIT offset wasn't reset**, then if you disable the XIT it's state will be saved. When you'll activate the XIT next time, transceiver will set the offset according to the previous value.

12 SHIFT BUTTONS OPERATION

SHIFT function allows to enable second functions of the front panel buttons.

Press and hold the **SHIFT** button for about 0.5-0.8 sec to enable SHIFT mode and activate second functions of the front panel buttons. Orange SHIFT indicator on the transceiver's front panel signals that the SHIFT function is active.

Note:

 *The second functions of the front panel buttons will be available in the new software releases. They are reserved at this point.*

13 DIGITAL MODES OPERATION

MB1 transceiver allows you to work with the digital modes with the help of the certain programs (are not provided by the manufacturer).

Note:

 *More information about the MB1 with the digital modes and popular programs will be explained in the new version of the User Manual.*

14 RX2 OPERATION

MB1 transceiver has the second software **RX2** receiver with the panorama up to 312 kHz and two independent Sub-receivers VFO A and VFO B.

The second receiver may receive on any band in one Nyquist zone, in other words **RX1** and **RX2** may simultaneously receive in the 0...80 MHz or 80-160 MHz. **RX2** has independent controls and indicators.

RX2 receiver displayed in the separate window and requires additional external display for comfortable usage.

To enable the **RX2** receiver - press the **RX2** button on the front panel of the transceiver.

How to control the tuning of the **RX2** receiver you may read here [Frequency tuning](#).^{D147}

Note:

 **RX2** window controls will be described in the the new version of the User Manual .

 **RX2** window controls are similar to the ExpertSDR2 controls for the SunSDR2 PRO transceiver. User manual for this software you may find [here](#) .
